

Automotive & Fleet Service Equipment ↻

Battery Chargers, Starters & Testers | Exhaust Hoses & Accessories
Shop Tools & Supplies | Lubrication Equipment | Safety Products





Battery Chargers & Testers

12V 10A PROSERIES RAPID CHARGER

- **Microprocessor-controlled**
- Multi-stage charging
- **SERVICE MODE:** maintains voltage at 13.6V to prevent discharge
- Start/Stop interface
- Reverse hook-up protection
- Charging status LED indicators
- Hook attachment
- **SCHU ECO ENERGY:** Meets the highest industry standards
- DOE compliant



341-00117

ASCOT NO.	MFG. NO.	DESCRIPTION
341-00117	DSR117	12V 10A ProSeries Rapid Charger

PROSERIES 12V 2200 PEAK AMP JUMP STARTER WITH USB AND DC POWER

- **POWERFUL PERFORMANCE: 525 CA, 350 CCA**
- High output AGM battery
- 2A external automatic charger
- 2.1A USB port
- 12V DC outlet
- Digital display
- ON/OFF switch
- Reverse connection warning
- **Schu Eco Energy:** Meets the highest industry standards



341-00114

ASCOT NO.	MFG. NO.	DESCRIPTION
341-00114	DSR114	ProSeries 12V 2200 Peak Amp Jump Starter with USB and DC Power

6V/12V 125A PROSERIES BATTERY CHARGER/ENGINE STARTER

6<>2A Charge Maintain, 15<>40A Boost/Service Mode, 125A Engine Start

- **125A ENGINE START:** Powerful enough for SUVs, trucks and large engines
- **BOOST MODE:** Quickly brings deeply discharged battery back to life
- **SERVICE MODE:** Maintains voltage at 13.6V to prevent discharge
- Battery tester
- Scrolling digital display
- Heavy-duty construction
- 125A clamps with copper cable
- Built-in cord management
- Auto voltage detection
- Reverse hook-up protection
- **SCHU ECO ENERGY:** Meets the highest industry standards
- DOE compliant



341-00118

ASCOT NO.	MFG. NO.	DESCRIPTION
341-00118	DSR118	6V/12V 125A ProSeries Battery Charger/Engine Starter

PROSERIES 1800 PEAK AMP JUMP STARTER

Jump Starter + 12V DC power source

- **OUTPUT CURRENT (PEAK):** 1800A
- **DIMENSIONS:** 8.25" x 12.38" x 12"
- **WEIGHT:** 19.59 lb.
- **WARRANTY PERIOD:** 1 year
- **800 PEAK AMPS:** Power for jump starting vehicles in emergencies
- **BUILT-IN CHARGER:** For automatic charging of internal battery
- **LED INDICATORS:** For charging and status of internal battery
- Maintenance-free, sealed lead-acid AGM battery
- 12V DC power outlet with overload and short-circuit protection
- Heavy-duty clamps fit both top- and side-mount batteries
- 4-gauge, 28" flex performance cable
- Compact, durable and corrosion-proof polypropylene case
- **SCHU ECO ENERGY:** Meets the highest industry standards



341-00119

ASCOT NO.	MFG. NO.	DESCRIPTION
341-00119	DSR119	ProSeries 1800 Peak Amp Jump Starter



AUTO & FLEET SERVICE // BATTERY CHARGERS & TESTERS



12V 250A PROSERIES BATTERY CHARGER/ENGINE STARTER

4A Maintain, 15A Fast Charge, 25<>50A BOOST, 250A Engine Start, Professional Wheel Charger

- **Charges standard, AGM and Gel and deep-cycle batteries** ▪ **250A ENGINE START:** Powerful enough for SUVs, trucks and large engines
- **25<>50A BOOST MODE:** Quickly brings deeply discharged battery back to life
- **MICROPROCESSOR-CONTROLLED:** Automatically adjusts amperage rate, to charge and maintain
- **MULTI-STAGE CHARGING:** For added precision, safety and battery life
- **FLOAT MODE MONITORING:** Maintains optimum battery charge
- Reverse hook-up protection
- Digital display, LED indicators and push-button controls
- Start/Stop interface
- **EXTRA-LONG OUTPUT CABLES:** 17 ft. total reach
- Retractable handle
- Safe for outdoor use
- **SCHU ECO ENERGY:** Meets the highest industry standards

6/12V 275A PROSERIES BATTERY CHARGER/ENGINE STARTER

4A Maintain, 15A Fast Charge, 20<>60A BOOST, 275/125A Engine Start, Professional Wheel Charger

- **Professional wheel charger with flash reprogramming** ▪ Charges standard, AGM and Gel and deep-cycle batteries
- **125A (6V)/275A (12V) ENGINE START:** Powerful enough for SUVs, trucks and large engines
- **20<>60A BOOST MODE:** Quickly brings deeply discharged battery back to life
- **65A FLASH REPROGRAM MODE**
- **MEMORY SAVER MODE:** For saving vehicle settings while changing the battery
- **MICROPROCESSOR-CONTROLLED:** Automatically adjusts amperage rate, to charge and maintain
- **MULTI-STAGE CHARGING:** For added precision, safety and battery life
- **FLOAT MODE MONITORING:** Maintains optimum battery charge
- Reverse hook-up protection
- Digital display, LED indicators and push-button controls
- Start/Stop interface
- **EXTRA-LONG OUTPUT CABLES:** 17 ft. total reach
- Retractable handle
- Safe for outdoor use
- **SCHU ECO ENERGY:** Meets the highest industry standards

6/2/40/20/250/125A 12/24V AUTOMATIC BATTERY CHARGER/ENGINE STARTER

- **250A/12V AND 125A/24V ENGINE START:** Powerful enough for SUVs, trucks and large engines
- **40A OR 20A BOOST MODE:** Quickly brings deeply discharged batteries back to life
- **MULTI-FUNCTION BATTERY TESTER:** For battery status and charging system analysis
- **MICROPROCESSOR-CONTROLLED:** Automatically adjusts amperage rate, to charge and maintain
- **MULTI-STAGE CHARGING:** For added precision, safety and battery life
- **FLOAT MODE MONITORING:** Maintains optimum battery charge
- Auto voltage detection
- Reverse hook-up protection
- **SCROLLING DIGITAL DISPLAY:** Gives step-by-step instructions to properly charge your battery
- LED indicators and push-button controls
- **4-GAUGE OUTPUT CABLES:** Stay flexible in cold weather
- Clamps and cords on front of unit
- Convenient clamp rest in handle
- Compact wheels for easy storage
- **SCHU ECO ENERGY:** Meets the highest industry standards



341-00121

ASCOT NO.	MFG. NO.	DESCRIPTION
341-00121	DSR121	12V 250A ProSeries Battery Charger/Engine Starter



341-00122

ASCOT NO.	MFG. NO.	DESCRIPTION
341-00122	DSR122	6/12V 275A ProSeries Battery Charger/Engine Starter



341-01352

ASCOT NO.	MFG. NO.	DESCRIPTION
341-01352	SCI352	6/2/40/20/250/125A 12/24V Automatic Battery Charger/Engine Starter



AUTO & FLEET SERVICE // BATTERY CHARGERS & TESTERS

➔ Battery Chargers

Battery Chargers & Testers (cont.)



SHUMACHER OBDII MEMORY SAVER DETECTOR

OBDII Memory Saver Detector automatically detects if the vehicles electronics will allow this device to save on-board data

- **Fully automatic** ▪ Standard fuse protected auxiliary input plug ▪ Easy to follow 3-step instructions printed on unit ▪ LED indicators ▪ Works on all vehicles equipped with a standard OBDII port



343-62350



BATTERY CONDUCTANCE & ELECTRICAL SYSTEM ANALYZER

Advanced diagnostic solution offering full electrical system testing capabilities (battery, starting, and charging) for regular flooded batteries and battery formats designed for start-stop vehicles

- Enhanced Flooded Battery (EFB) ▪ AGM (Flat Plate and Spiral) ▪ Test results include a battery State of Health (SOH) graph to help identify weak batteries at a glance

Additional key features of this versatile, full-featured tool:

- Large, backlit display enables easy viewing ▪ Built-in printer generates detailed, shareable results ▪ Run tests and print results in English, Spanish or French ▪ Durable, field-replaceable cable and clamp assembly ▪ **LONG-LIFE THERMAL PRINTER:** No ink cartridge to replace ▪ Full rubber boot protects tester from shock and abuse ▪ Sturdy tool bag included to provide protection during storage or transit



341-00650

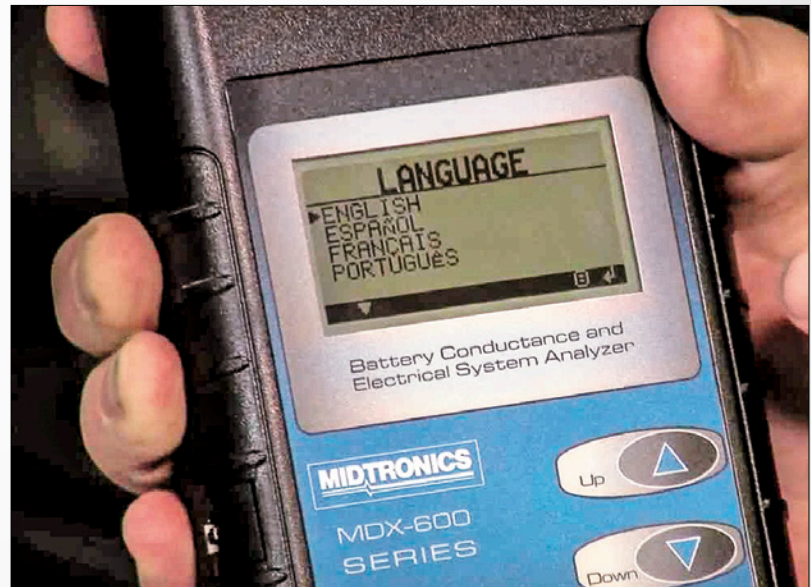

The Battery Conductance & Electrical System Analyzer in use.

ASCOT NO.	MFG. NO.	DESCRIPTION
343-62350	OBD-L	Shumacher OBDII Memory Saver Detector

ASCOT NO.	MFG. NO.	DESCRIPTION
342-00650	MDX-650P SOH	Battery Conductance & Electrical System Analyzer



BATTERY AND SYSTEM ANALYZER

- **Conductance Profiling™ offers increased decisiveness (less Charge & Retest) and a battery Reserve Capacity condition check**
- Supports future vehicle/battery technologies via software updates with subscription to BMIS Program Maintenance
- *Optional CPX-901 dock enables automated overnight updates*
- 3.5-inch color display offers more on-screen information and provides convenient option for sharing battery diagnostic results with customers
- Ergonomic shape, size and grip is easy to carry and hold
- Field-replaceable cable
- On-tool Wi-Fi and Bluetooth capabilities support flexible networking capabilities
- Vehicle database-driven testing automatically sets correct battery parameters, increasing user confidence and customer satisfaction
- *Year/Make/Model manual entry or VIN capture via optional 1D/2D barcode scanner* establishes vehicle records & tracks process compliance

BATTERY DIAGNOSTIC SERVICE SYSTEM

- **Conductance Profiling™ offers increased decisiveness (less Charge & Retest) and battery Reserve Capacity condition check**
- Supports future vehicle/battery technologies via automatic software updates delivered wirelessly with BMIS Program Maintenance
- Provides battery registration app and reset checklist
- Detachable controller enables easier scanning and system test
- Five-inch color touchscreen display offers more on-screen information and provides convenient option for sharing battery diagnostic results with customers
- Ergonomic shape, size and grip is easy to carry and hold
- VIN capture via integrated camera establishes vehicle records & tracks process compliance
- On-tool Wi-Fi and Bluetooth capabilities support flexible networking capabilities
- Vehicle database-driven testing automatically sets correct battery parameters, increasing user confidence and customer satisfaction

POWER SUPPLY CHARGER

The Midtronics MSP-070 Power Supply Charger provides clean, reliable power for charging and maintaining battery state-of-charge during service reflash, complex maintenance, and in the showroom

- Avoid potential battery damage from drain during vehicle service
- Maintain vehicle electronic and accessory settings
- Return battery in optimum condition to prevent potential no-starts and ensure customer satisfaction
- Selectable voltages of 13.2, 13.6, and 14.4 VDC via 3-position switch for showroom battery maintenance, reflash, and extended maintenance events
- Low profile to fit under vehicles
- Dynamic internal fan control offers quiet operation
- CAN interface
- 2m, 3m, and 5m cable length options; field-replaceable
- Integrated carry handle

AUTO & FLEET SERVICE // BATTERY CHARGERS & TESTERS



342-00900



342-05000



341-00070

- CLEAN, RELIABLE POWER
- LOW PROFILE

ASCOT NO.	MFG. NO.	DESCRIPTION
342-00900	CPX-900	Battery and System Analyzer

ASCOT NO.	MFG. NO.	DESCRIPTION
342-05000	DSS-5000	Battery Diagnostic Service System

ASCOT NO.	MFG. NO.	DESCRIPTION
341-00070	MSP-070	Power Supply Charger



⚠ **WARNING:** For more information go to www.P65Warnings.ca.gov.

Service Equipment

BARTEC QUICK SERVICE TOOL

Keep your complex scan tool working on higher paying, more complicated service work, and use the QST300 instead. The QST300 is an easy to setup and easy to operate tool that resets the Change Oil Light, Relaxes the rear, electronic parking brake, and registers a new battery upon installation. The QST300 is designed to offer powerful yet affordable tool solutions for services like Oil Changes, Brake Pad Replacement and Battery Replacement.

▪ **BATTERY MANAGEMENT**

TECHNOLOGY: The QST recalibrates the necessary control modules after a battery replacement.

▪ **OIL SERVICE LIGHT RESET:** Clears the warning light on the vehicles that requires this step after an oil change.

▪ **ELECTRONIC PARKING BRAKE**

DISENGAGE: The QST300 relaxes the electronic parking brake so that brake service can be completed.

▪ **LARGE DISPLAY:** Easy to see and navigate the very intuitive operation. On screen instruction keeps the repair process moving forward.

▪ **EASY TO UPDATE:** Simply log into the QST300 update suite [free download] and keep your tool up to date. Tool comes with one year's worth of updates. For additional years, update certificates are sold separately.

▪ **BATTERIES NOT REQUIRED:** The QST300 is powered by the car through the OBDII connection.



351-30000



The Bartec Quick Service Tool in use.



ASCOT NO.	MFG. NO.	DESCRIPTION
351-30000	QST300	Quick Service Tool for Battery, Oil and Brake Service Work

AUTO & FLEET SERVICE // SERVICE EQUIPMENT



➔ Revive Engine Cleaner

REVIVE ENGINE CLEANER

A unique product for cleaning Turbo and Direct injection [GDI] engines! Revive is a water based cleaner that is sprayed into the “cold air side” of the intake system. It is very unique in that due to its chemical structure, the product is able to survive the combustion process and clean virtually anything with carbon and soot build up. It is NOT flammable and is SAFE FOR THE ENGINE! Use Revive and avoid potential tear downs.

- **GDI ENGINES HAVE A BUILT IN PROBLEM:** Because fuel is directly injected into the combustion chamber, it does not pass over the valves and other surfaces, as a result carbon builds up causing increasingly poor performance.
- **CLEANS GDI AND TURBO CHARGED ENGINES:** Revolutionary water based formula is able to survive the combustion process and clean more carbon and soot than solvent based cleaners
- **DIRECT APPLICATION:** Revive is applied directly through the cold air intake, and goes right to work on surfaces that have carbon and soot build up.
- **SAFE TO USE:** Revive is water based so no dangerous solvents or flammable liquids to worry about.



333-49900



333-49911



333-49930



333-49601



333-49602

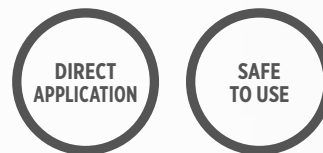

333-49603

ASCOT NO.	MFG. NO.	DESCRIPTION
333-49900	1449-9000	Revive Engine Cleaner Kit for Engines Smaller than 5.0 Liters
333-49930	1449-9300	Revive Engine Cleaner Kit for Engines Larger than 5.0 Liters
333-49911	1449-9011	Revive Engine Cleaner Maintenance Application
333-49601	1449-6001	Countertop Display with Tri-Fold Holder
333-49602	1449-6002	Informative Counter mat
333-49603	1449-6003	Revive Product Information for Consumers

AUTO & FLEET SERVICE // SERVICE EQUIPMENT

➔ B'Laster Lubricants & Greases



Lubricants & Sealants

B'LASTER PENETRATING LITHIUM GREASE

- **High-quality lithium grease** ▪ Time-release penetrating action ▪ Superior lubrication & protection
- **QUANTITY:** 6 per case

ASCOT NO.	MFG. NO.	DESCRIPTION
328-00008	GR-8A-PB	B'laster Penetrating Lithium Grease, 8 oz.



328-00008

B'LASTER PENETRATING GREASE

- **High-quality synthetic grease** ▪ Time-release penetrating action ▪ Superior anti-seize properties ▪ Superior grease fitting lubrication & protection
- **QUANTITY:** 6 per case Brush-top 8 oz., 10 per case 14 oz.

ASCOT NO.	MFG. NO.	DESCRIPTION
328-00018	GR-8J-PB	B'laster Penetrating Grease (Brush-Top), 8 oz.
328-00314	GR-14C-PB	B'laster Penetrating Grease, 14 oz.



328-00018

328-00314

B'LASTER MAX HD GREASE

- **Excellent high-temp lubrication** ▪ Superior corrosion protection ▪ Does not drip in severe conditions ▪ Protects up to high temperatures of 550°F (dropping point) ▪ **QUANTITY:** 10 per case



ASCOT NO.	MFG. NO.	DESCRIPTION
328-00014	GR-14C-HDG	B'laster Max HD Grease, 14 oz.

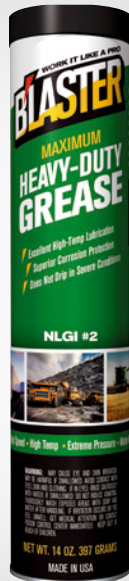

328-00014

B'LASTER ALL-PURPOSE LUBRICANT

- **Teflon™ fluoropolymer reduces friction & wear** ▪ Protect surfaces ▪ Over 1000 indoor & outdoor applications ▪ Enhance performance ▪ Light vanilla scent ▪ Use on all moving parts
- **QUANTITY:** 12 per case

ASCOT NO.	MFG. NO.	DESCRIPTION
328-00050	PB-50	B'laster All-Purpose Lubricant, 8 oz.



328-00050



B'LASTER SILICONE LUBE

- **Teflon™ fluoropolymer enhances performance** ▪ Long-lasting lubrication ▪ Won't accumulate dust & dirt ▪ **QUANTITY:** 12 per case



ASCOT NO.	MFG. NO.	DESCRIPTION
328-00016	16-SL	B'laster Silicone Lube, 11 oz.



328-00016



B'LASTER EXTRA TACKY RED GREASE

- **Maximum anti-wear & extreme pressure protection** ▪ Resists thinning in high temps (550°F dropping point) ▪ Protects against rust & corrosion ▪ **QUANTITY:** 10 per case

ASCOT NO.	MFG. NO.	DESCRIPTION
328-00114	GR-14C-HTR	B'laster Extra Tacky Red Grease, 14 oz.

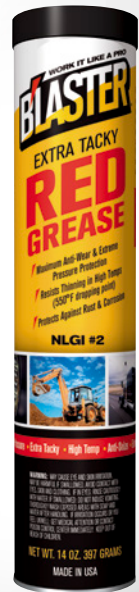

328-00114



AUTO & FLEET SERVICE // LUBRICANTS & SEALANTS



➔ B'Laster Lubricants, Solvents & Greases

B'LASTER DRY LUBRICANT

- Teflon™ fluoropolymer helps reduce friction & wear
- Enhance performance
- Protect surfaces
- **QUANTITY:** 12 per case

ASCOT NO.	MFG. NO.	DESCRIPTION
328-00116	16-TDL	B'laster Dry Lubricant, 9.3 oz.

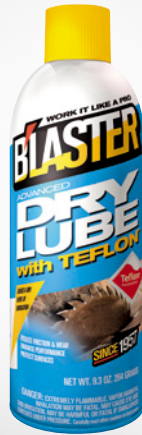

328-00116



328-00214

B'LASTER PRO GRADE MULTI-PURPOSE GREASE

- Superior general purpose lubrication
- Protects against rust & corrosion
- Excellent water resistance
- **QUANTITY:** 10 per case



ASCOT NO.	MFG. NO.	DESCRIPTION
328-00214	GR-14C-MP	B'laster Pro Grade Multi-Purpose Grease, 14 oz.

B'LASTER PARTS WASH SOLVENT

- Cuts through cutting oil, motor oils & grease
- **HIGH FLASHPOINT FORMULA:** 145°F
- Leaves parts residue free
- Safe for use on all metals, most plastics & painted surfaces



393-00005

393-00128

ASCOT NO.	MFG. NO.	DESCRIPTION
393-00128	128-PWS	B'laster Parts Wash Solvent, 1-Gallon (4 per case)
393-00005	5-PWS	B'laster Parts Wash Solvent, 5-Gallon Pail

B'LASTER CITRUS DEGREASER

- Fast-acting formula rinses clean with water
- Safely cleans stainless steel
- Spray on & wipe off tough grease
- **QUANTITY:** 12 per case



ASCOT NO.	MFG. NO.	DESCRIPTION
395-00016	16-CBD	B'laster Citrus Degreaser, 11 oz.

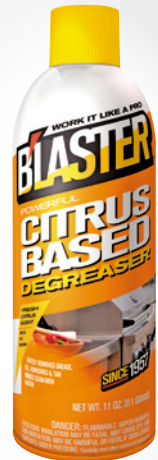

395-00016

B'LASTER GARAGE DOOR LUBE

- Teflon™ fluoropolymer reduces friction & wear
- Won't accumulate dust & dirt
- Quiets noisy operation
- **QUANTITY:** 12 per case



ASCOT NO.	MFG. NO.	DESCRIPTION
395-00116	16-GDL	B'laster Garage Door Lube, 9.3 oz.



395-00116

B'LASTER WHITE LITHIUM GREASE

- Keep surfaces lubricated in extreme temperatures
- Protects against moisture & oxidation
- Leaves a thick layer of grease
- **QUANTITY:** 12 per case



ASCOT NO.	MFG. NO.	DESCRIPTION
395-00216	16-LG	B'laster White Lithium Grease, 11 oz.



395-00216

AUTO & FLEET SERVICE // LUBRICANTS & SEALANTS

➔ Exhaust Ventilation System, Flarelock Hose, Tailpipe Adapters

Exhaust Hoses & Tailpipe Adapters

CRUSHPROOF EXHAUST VENTILATION SYSTEM

DOOR PORTS



391-00130 391-00125

Y-CONNECTORS



391-00240 391-00230

SPLICE CONNECTORS



391-21040 391-20040

ELBOWS



391-00430 391-00330

OVERHEAD DUCT



391-22040

Y-ASSEMBLY



391-53000

ASCOT NO.	MFG. NO.	DESCRIPTION
391-00125	DF25	2-1/2" Rubber Door Port
391-00130	ADF30	3" Aluminum Door Port
391-00140	ADF40	4" Aluminum Door Port
391-00225	RY25	2-1/2" Rubber Y-Connector
391-00230	RY30	3" Rubber Y-Connector
391-00240	AY40	4" Aluminum Y-Connector
391-20030	AC30	3" Aluminum Splice Connector
391-20040	AC40	4" Aluminum Splice Connector
391-20050	AC50	5" Aluminum Splice Connector
391-20060	AC60	6" Aluminum Splice Connector
391-21025	SP25	2-1/2" Rubber Splice Connector
391-21030	SP30	3" Rubber Splice Connector
391-21040	SP40	4" Rubber Splice Connector
391-00325	AEL25	2-1/2" Aluminum Elbow
391-00330	AEL30	3" Aluminum Elbow
391-00340	AEL40	4" Aluminum Elbow
391-00350	AEL50	5" Aluminum Elbow
391-00425	EB25	2-1/2" Rubber Elbow
391-00430	EB30	3" Rubber Elbow
391-22150	OC50D	5" Overhead Duct Connector W/Damper
391-22160	AC-60-OC	6" Overhead Duct Connector
391-22030	OC30	3" Overhead Duct Connector
391-22040	OC40	4" Overhead Duct Connector
391-22050	OC50	5" Overhead Duct Connector
391-52500	YA250	2-1/2" Y-Assembly
391-53000	YA300	3" Y-Assembly
391-54000	YA400	4" Y-Assembly

FLARELOCK HOSE

▪ For use with cars and small trucks ▪ Flared end on each length to permit connection of two or more lengths of same size hose



391-15350

ASCOT NO.	MFG. NO.	DESCRIPTION
391-15250	FLT250	2-1/2" x 11' Flarelock Hose
391-15300	FLT300	3" x 11' Flarelock Hose
391-15350	FLT350	3-1/2" x 11' Flarelock Hose
391-15400	FLT400	4" x 11' Flarelock Hose

TAILPIPE ADAPTERS

▪ Crushproof offers a complete line of accessory items



ASCOT NO.	MFG. NO.	DESCRIPTION	TAILPIPE STYLE	TAILPIPE SIZE	HOSE ID
391-93000	TPA3000	Split Adapter	Separated	Up To 2-1/2"	3"
391-90250	F250	Straight W/ Hook & Chain	Single	Up To 2"	2-1/2", 3", 3-1/2"
391-90300	F300	Straight w/ Hook & Chain	Single	Up To 2-1/2"	2-1/2", 3", 3-1/2"
391-90350	F350	Straight w/ Hook & Chain	Single	Up To 3"	2-1/2", 3", 3-1/2"
391-90400	F400	Straight w/ Hook & Chain	Single	Up To 3-12/16"	3-1/2", 4", 5
391-90600	DSR600	Stack Adapter	Diesel Stack	Up To 5-1/2"	4", 5"
391-90606	DSR600-6	Stack Adapter	Diesel Stack	Up To 5-1/2"	5", 6"
391-91000	UNA1000	Plug-n Unihose	All	All	3"
391-90475	F475	Oval Adapter (2.5" x 6")	Twin Oval	2", 5-1/2"	3", 4"
391-90575	F575	Oval Adapter (3.5" x 8.5")	Twin Oval	2", 5-1/2"	3", 4"
391-91250	RA250	Bell w/Snaps	All	All	3"
391-91300	RA300	Bell w/Snaps	All	All	3"

➔ Industrial Bench Grinders, Swivel Base Bench Vises

Bench Grinders & Shop Vises



INDUSTRIAL BENCH GRINDERS

- **UL listed motor** ▪ Pre-lubricated and enclosed ball bearings ▪ Cast iron wheel guards and dust vents ▪ One piece quick adjusting spark guards ▪ Large eye shields with quick adjustment ▪ Adjustable tool rests ▪ Heavy duty guarded toggle switch on 8" and 10" ▪ Fine and coarse vitrified wheels included ▪ Rubber mounts prevent movement ▪ 3-conductor cord with 3-prong plug



311-77101



311-77172

ASCOT NO.	MFG. NO.	DESCRIPTION
311-77101	577101	JBG-6A: Bench Grinder, 6" Wheel
311-77102	577102	JBG-8A: Bench Grinder, 8" Wheel
311-77103	577103	JBG-10A: Bench Grinder, 10" Wheel
311-77172	577172	JPS-2: Optional Pedestal

BENCH GRINDER MODELS AT A GLANCE

Model No.	JBG-6A	JBG-8A	JBG-10A
ASCOT. No.	311-77101	311-77102	311-77103
Shaft Diameter (In.)	1/2	5/8	1
Wheel Diameter (Dia. x W/ In.)	6 x 3/4	8 x 1	10 x 1
Wheel Speed (RPM)	3450	3450	1725
Wheel Grits	36/60	36/60	24/46
Motor (HP)	1/2HP, 115V, 1Ph	1HP, 115V, 1Ph	1-1/2HP, 115V, 1Ph
Overall Dimensions (LxWxH/ In.)	18 x 10-1/2 x 8-1/2	19 x 12-1/2 x 10	24-1/2 x 12-1/4 x 13
Net Weight (Lb.)	38	60	110

6" SWIVEL BASE BENCH VISE

- **Heavy duty 30,000 PSI castings for long life and added strength** ▪ Swivel bar rotates 360° and has double lockdowns ensuring maximum stability ▪ Powder coat paint resists scratches and provides a tough durable finish ▪ Replaceable hardened steel top and pipe jaws



311-21500



ASCOT NO.	MFG. NO.	JAW WIDTH	THROAT DEPTH	PIPE CAP.	WT.
311-21500	21500	6"	4-1/8"	1/4 - 3-1/2	69.35 lb.

AUTO & FLEET SERVICE // BENCH GRINDERS & SHOP VISES

➔ Professional Shop Vises, Tradesman Vises, Mechanics Pro Vises

Bench Grinders & Shop Vises (cont.)



PROFESSIONAL SHOP VISES

- Cast iron jaw with heavy internal ribs for added strength. Pipe jaws are permanently cast in for greater channel strength
- Cast iron back jaw designed for exceptional alignment with the front jaw
- "V" notched, replaceable/reversible jaws made of carbon steel and heat treated for extra strength
- Specially designed spring loaded handle and screw guarantees quick jaw response
- Front jaw beam covers and protects screws
- Steel handle balls forged from handle stock
- Lifetime Casting Warranty

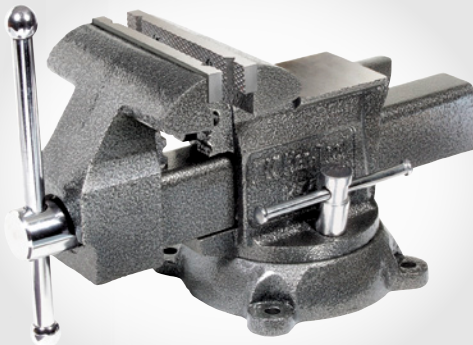

311-64055

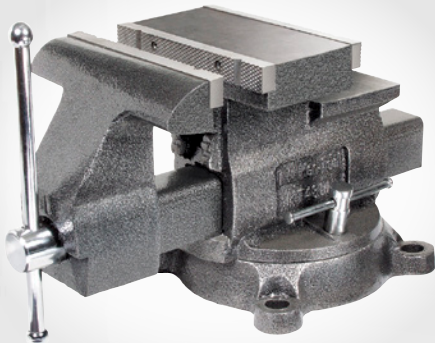

311-64800

ASCOT NO.	MFG. NO.	JAW WIDTH	JAW OPENING	THROAT DEPTH	PIPE CAP.	WEIGHT
311-64055	64055	5-1/2"	6-1/2"	3-3/16"	1/8"	30 lb.
311-64065	64065	6-1/2"	7-1/2"	3-3/4"	1/8"-2-1/2"	41 lb.
311-64650	64650	6-1/2"	7"-10"	3-3/16"	1/8"-2-1/2"	50 lb.
311-64800	64800	8"	8"-11"	3-3/4"	1/8"-3"	74 lb.

TRADESMAN VISES

- Fully sealed one-piece spindle nut assembly for a lifetime of smooth operation
- Precision machined slide bar to eliminate movement in front jaw regardless of opened position
- 60,000 PSI ductile iron body, jaw & base
- Machined steel serrated jaws with black phosphate coating for increased durability and corrosion resistance
- Lifetime Warranty



311-28806

ASCOT NO.	MFG. NO.	JAW WIDTH	OPENING CAPACITY MAX.	THROAT DEPTH	PIPE JAW CAPACITY	WEIGHT
311-28805	28805	4-1/2"	3-1/2"	3-1/2"	1/4" - 3-1/2"	42 lb.
311-28806	28806	5-1/2"	5"	3-5/8"	3/8" - 3-1/2"	42 lb.
311-28807	28807	6-1/2"	6"	4-1/4"	3/8" - 4"	42 lb.
311-28808	28808	8"	6-3/4"	5"	3/8" - 4-1/2"	111 lb.

MECHANICS PRO VISES

- Enclosed Spindle for smooth operation
- Precision machined slide bar to eliminate movement in front jaw regardless of opened position
- Needle roller thrust bearing to easily apply and release clamping force
- 60,000 PSI Jaw and Base
- Lifetime Warranty

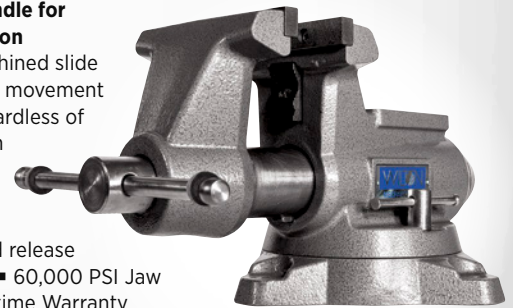

311-28811



ASCOT NO.	MFG. NO.	JAW WIDTH	OPENING CAPACITY MAX.	THROAT DEPTH	PIPE JAW CAPACITY	WEIGHT
311-28810	28810	4-1/2"	4"	3-1/2"	1/4" - 3"	31 lb.
311-28811	28811	5-1/2"	5"	3-5/8"	1/4" - 3"	38 lb.
311-28812	28812	6-1/2"	6"	4-3/8"	1/4" - 4"	56 lb.
311-28813	28813	8"	8-1/2"	4-1/2"	1/2" - 4"	83 lb.
311-28814	28814	10"	12"	5-1/4"	1/2" - 5"	115 lb.

AUTO & FLEET SERVICE // BENCH GRINDERS & SHOP VISES



Pliers & Screwdrivers

7" CUTTING PLIER WITH END CUTTER

- **Perfectly mated cutter, heat treated to hold its edge** ▪ Polished high carbon drop forged steel
- CHANNELLOCK BLUE® comfort grips

ASCOT NO.	MFG. NO.	DESCRIPTION
319-00357	357	7" Cutting Plier with End Cutter



5" CUTTING PLIER, BOX JOINT

- **Perfectly mated cutters, scientifically heat treated to hold their edge** ▪ Precision made of fine polished, high carbon drop forged steel
- Distinctive CHANNELLOCK BLUE® comfort grips

ASCOT NO.	MFG. NO.	DESCRIPTION
319-00435	435	5" Cutting Plier, Box Joint



6" DIAGONAL CUTTING PLIER, BOX JOINT

- **Perfectly mated cutter, heat treated to hold its edge** ▪ Polished, high carbon drop forged steel
- Distinctive CHANNELLOCK BLUE® comfort grips

ASCOT NO.	MFG. NO.	DESCRIPTION
319-00436	436	6" Diagonal Cutting Plier, Box Joint



6" SLIP JOINT PLIER, WIRE CUTTING SHEAR

- **Thick Nose Pliers** ▪ Shear-type wire cutter
- Precision made of fine polished, high carbon drop forged steel
- Patented PermaLock® fastener eliminates nut and bolt failures
- CHANNELLOCK BLUE® comfort grips

ASCOT NO.	MFG. NO.	DESCRIPTION
319-00526	526	6" Slip Joint Plier, Wire Cutting Shear



SLOTTED SCREWDRIVER

- Tip Width: 1/4" ▪ Blade Length: 6" ▪ Handle Length: 4" ▪ Overall Length: 10" ▪ Bulk Packaged
- **MADE IN THE USA**

ASCOT NO.	MFG. NO.	DESCRIPTION
319-09125	029A66S	Slotted Screwdriver



#2 PHILLIPS SCREWDRIVER

- **Cushion Grip for comfort** ▪ Blade Length: 4" ▪ Handle Length: 4.5" ▪ Overall Length: 8.5" ▪ Bulk Packaged
- **MADE IN THE USA**

ASCOT NO.	MFG. NO.	DESCRIPTION
319-09144	R44PGB	#2 Phillips Screwdriver



1/4" SOCKET DRIVER

- **Shank made from chrome vanadium**
- Overall Length: 6" ▪ Shank Length: 2-1/2" ▪ Ideal for use with the TPMS 11mm x 12mm flip socket
- Screwdriver handle, made from durable plastic-like material
- **MADE IN THE USA**

ASCOT NO.	MFG. NO.	DESCRIPTION
319-72521	7252100	1/4" Socket Driver with Screwdriver Handle



8-PIECE PROFESSIONAL SCREWDRIVER SET

- **Includes 5 flat tip drivers and 3 Phillips tip drivers:**

SLOTTED: 3/8" x 8", 5/16" x 6", 1/4" x 4", 3/16" x 3", 1/4" x 1-1/2"

PHILLIPS: #2 Phillips x 4", #1 Phillips x 3", #2 Phillips x 1-1/2"

- Black handles
- Hardened chrome vanadium shafts
- Vapor blasted magnetic tips
- Packaged in molded plastic tray for storage
- Hex bolsters for extra turning power



ASCOT NO.	MFG. NO.	DESCRIPTION
319-19800	19800	8-Piece Professional Screwdriver Set

319-19800

➔ Squeegees, Brushes, Brooms, Hand Wipes, Hand Cleaner

Shop Cleaners & Brushes



FLOOR SQUEEGEES

- Black neoprene rubber blade designed for rough, heavy use
- Handle not included, order separately



395-45507

ASCOT NO.	MFG. NO.	DESCRIPTION
395-45507	45507	24" Straight Squeegee
395-44020	44020	Handle

PALMYRA FILL GARAGE BRUSHES/BROOMS

- Excellent for heavy duty sweeping of concrete, sidewalks and garage floors
- Can be used for wet or dry sweeping



395-42023

ASCOT NO.	MFG. NO.	DESCRIPTION
395-42023	42023	24" Garage Brush-Palmyra



PREMIUM HAND WIPES

Winntec's premium hand wipes are the perfect way to keep clean in any workshop.



- Powerful cleaning
- Moisturizing
- Great for hands and surfaces
- Water saving
- 336 wipes per box

ASCOT NO.	MFG. NO.	DESCRIPTION
395-83039	G083039	Premium Hand Wipes



PLASTIC HANDLED BRASS SIDEWALL BRUSH

- Densely packed brass bristles
- Great for cleaning white sidewall tires
- BRISTLE LENGTH: 3/4" | OVERALL

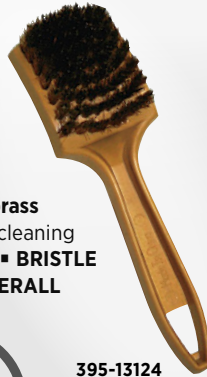

395-13124



ASCOT NO.	MFG. NO.	DESCRIPTION
395-13124	VT-932	Plastic Handled Brass Sidewall Brush

WOODEN HANDLED WIRE BRUSH WITH METAL SCRAPER

- Cleans rust from rims and wheels
- 19 rows of steel bristles
- Slightly curved wooden handle
- Metal scraper included
- BRISTLE LENGTH: 1" | OVERALL LENGTH: 14-1/4"



535-00150



ASCOT NO.	MFG. NO.	DESCRIPTION
535-00150	VT-931	Wooden Handled Wire Brush with Metal Scraper



GOJO® SUPRO MAX™ HAND CLEANER

- Effective on oil, grease, paint, and adhesives
- Unique blend of cleaners and skin conditioners help leave skin feeling healthy
- Non-drying formula



395-72722

395-72724

ASCOT NO.	MFG. NO.	DESCRIPTION
395-72722	7272-D2	PRO™ TDX™ 2000 Starter Kit (1 Dispenser, 1 Refill)
395-72724	7272-04	2000 mL Refill (4 per case)

GOJO® NATURAL* ORANGEM™ PUMICE HAND CLEANER

- Effective on dirt, oil and grease
- Quick-acting, lotion hand cleaner with pumice scrubbers

*Natural citrus ingredient



395-72552

395-72554



395-09552

ASCOT NO.	MFG. NO.	DESCRIPTION
395-72552	7255-D2	PRO™ TDX™ 2000 Starter Kit (1 Dispenser, 1 Refill)
395-72554	7255-04	2000 mL Refill (4 per case)
395-09552	0955-02	2x 1-Gallon Pump Bottles





➔ Hand Cleaners, Hand Scrub, Dispensers

FULL BORE HAND CLEANER

- Rids hands of dirt and grease while leaving the skin soft and chap free
- Solvent free ▪ Economical ▪ Contains skin moisturizers ▪ Clean fragrance
- Never irritates or burns open wounds ▪ Rinses clean ▪ Keeps your sink clean ▪ Keeps your pipes clean
- Will not separate during hot months
- Long shelf life ▪ Neutral pH ▪ **MEETS AMERICAN CLEAN WATERS ACT**

RIDS
HANDS OF
DIRT AND
GREASE

LEAVES
HANDS SOFT
AND CHAP
FREE



395-00101



395-00102



395-00103



395-00104



395-00300



395-00125



395-00126

ASCOT NO.	MFG. NO.	DESCRIPTION
ULTRA FLOW		
395-00101	TSIGAL	Ultra Flow, 1 Gallon
395-00102	TSIGAL-FT	Ultra Flow, 1 Gallon Flat Top
395-00103	TSIGAL-16OZ	Ultra Flow, 16 oz. **
ULTRA FLOW DISPENSERS		
395-00104	Plastic Pump	Plastic Pump
395-00300	TS300-D	Stainless Steel Screw On Dispenser **
395-00125	TS125-D	Stainless Steel Wall Mount Dispenser
395-00126	TS125-FT-D	Stainless Steel Wall Mount Dispenser (Fits Flat Top)
SUPER GRIT		
395-40000	TS4000	Super Grit, 4 Gallon **
395-06400	TS6400	Super Grit, 64 oz.
EXTREME GREEN		
395-00400	MG-HS-4GAL	Extreme Green, 4 Gallon **
395-06401	MG-HS-64OZ	Extreme Green, 64 oz.



395-40000



395-00400



395-06400



395-06401

AUTO & FLEET SERVICE // SHOP CLEANERS & BRUSHES

➔ Rechargeable Work Light, CREE Head Light with Rechargeable Battery

Shop Lights & Service Stickers

COB RECHARGEABLE WORK LIGHT W/ USB CABLE

- **400LM brightness** ▪ Dimming Switch ▪ Features a hook on lamp head and base with magnet for hands-free operation ▪ **WORKING TIME:** Approx. 2.5 hrs.
- **CHARGING TIME:** Approx. 4 hrs. ▪ 8W COB LED



312-03007

HEAD LIGHT WITH RECHARGEABLE BATTERY

- **Hands-free, versatile and comfortable with adjustable straps** ▪ **MATERIAL:** Aluminum +ABS+PC ▪ **LED:** 1-piece high power CREE T6 bulb ▪ **BRIGHTNESS:** Approx. 500LM for high mode ▪ **4-MODE LED LAMPS:** High - Low - Strobe - off ▪ **WORKING TIME:** Approx. 6 hours on High; Approx. 12 hours on Low ▪ **CHARGING TIME:** Approx. 5 hours ▪ **RECHARGEABLE BATTERIES:** 2x 3.7V 1800mAh Li-ion batteries (3600mAh total battery capacity)
- Sensor Function ▪ *USB cable included*



312-03120

ASCOT NO.	MFG. NO.	DESCRIPTION
312-03007	TWL3007E	COB Rechargeable Work Light w/ USB Cable

ASCOT NO.	MFG. NO.	DESCRIPTION
312-03120	THL2019	CREE Head Light with Rechargeable Battery

➔ Waterproof Work Light, Static Cling Printer, Service Stickers

RECHARGEABLE WATERPROOF WORK LIGHT



▪ **Best in the industry, Ascot Supply Corporation's Rechargeable Waterproof Work Light is the brightest rechargeable work light available with its powerful 66 LED's (460 lumens)** ▪ Swivel hook for hanging ▪ Universal attachment hook can be used as a light stand or attached under a car hood ▪ Rechargeable battery ▪ *Replacement 12 V lighter adapter is also available and sold separately*



312-05224



312-25224

ASCOT NO.	MFG. NO.	DESCRIPTION
312-05224	CED5224A-AS	Rechargeable Waterproof Work Light
312-15224	CED522P3-AS	Replacement AC Adapter for Rechargeable Waterproof Work Light
312-25224	CED5224P1-AS	12V Lighter Adapter for Rechargeable Work Light

STATIC CLING PRINTER

▪ **Full feature Reminder Sticker Solution takes professionalism to a new level** ▪ Godex Printer pre-programmed to work out of the box ▪ **1 year parts and labor warranty** (6 months on print head) ▪ *Includes 1 ribbon*



399-11111

ASCOT NO.	MFG. NO.	DESCRIPTION
399-11111	FK-GX001-05	Static Cling Printer

STATIC CLING REMINDER STICKERS

▪ **Excellent item to promote repeat business** ▪ Keeps your name, the service to be done and the time to do it in constant view of the customer ▪ More effective than a door jam sticker ▪ Static cling vinyl will cling to almost any smooth surface ▪ No adhesive residue and they can be removed for cleaning and replacing ▪ Silk screen printing process for a high quality image and a writing strip that won't allow the ink to fade ▪ Generic design stickers as well as personalized stickers



399-00101

399-00103

ASCOT NO.	DESCRIPTION
399-00101	Air Pressure/Tire Rotation Static Cling Sticker
399-00102	Oil Change Static Cling Sticker
399-00103	Service Reminder Static Cling Sticker

AUTO & FLEET SERVICE // TIRE DISPLAYS, RACKS & CARTS

➔ Tire Shelving, Folding Racks, Wall Grid System

Tire Displays, Racks & Carts



3, 4 AND 5-TIER TIRE SHELVING

▪ **This storage system is ideal for areas where a forklift cannot be used since it is designed to maximize upright tire storage** ▪ This system is mainly used to store a small number of tires or store customers' tires ▪ **THREE ADJUSTABLE TIERS:** Perfect for tires alone or wheel-mounted ▪ Allows for storage of 330 tires in a 40-foot container ▪ *Fasteners for walls, floors and additional sections are included* ▪ Holds 9-11 tires per level ▪ Rails are tilted to hold tires properly ▪ Each section is designed to stand alone



751-00092

ASCOT NO.	MFG. NO.	CAPACITY	DIMENSIONS
751-00092	MTS-92	27 to 33 tires	92" x 16-3/8" x 92"
751-00924	MTS-924	36 to 44 tires	92" x 16-3/8" x 120"
751-00925	MTS-925	45 to 55 tires	92" x 16-3/8" x 155"

TRUCK TIRE AND LACING TIRE RACK

▪ **The truck tire rack is a storage system for truck and bus tires** ▪ The MLR can handle tires of up to 44 inches outside diameter, which would be about 7 tires stored on their tread ▪ The rack for truck tires can be stacked up to 6 high and can handle up to 2400 lb. per rack ▪ The lacing rack is a storage system for high volumes of PCR-SUV tires, which should be similar or identical since they need to be stored in an interlaced pattern — Interlaced storage saves a significant amount of space ▪ A single rack can hold 34 to 50 PCR-SUV tires, depending on tire diameters and the racks can be stacked 6 high



751-06061



ASCOT NO.	MFG. NO.	CAPACITY	DIMENSIONS
751-06061	MLR	7 TBR - 34 to 50 PCR-SUV Tires	85" x 48-1/2" x 52"

PASSENGER & LIGHT TRUCK FOLDING RACK

▪ **Flexible & mobile, this system helps you keep tire handling to a minimum and offers unparalleled versatility** ▪ It allows you to store a large number of tires when they are placed in a laced pattern but it also can be used for fewer tires if they rest on the tread ▪ The racks are made of heavy duty steel and are built for superior durability



751-03260



ASCOT NO.	MFG. NO.	CAPACITY	DIMENSIONS
751-03260	MLTFD	28-50 Tires	72" x 50" x 68"

WALL GRID SYSTEM

▪ **Holds 4 tires/wheels** ▪ **WEIGHT:** 57 lb.
▪ Packaged in a cardboard box

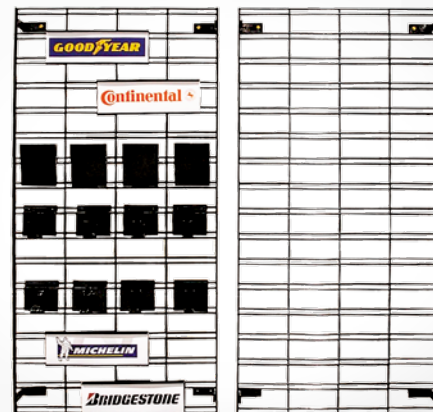

751-24481

ASCOT NO.	MFG. NO.	DESCRIPTION
751-24481	MWG-2448-KIT	Wall Grid Tire & Rim Display (Complete Kit)

AUTO & FLEET SERVICE // SHOP LIGHTS & SERVICE STICKERS



➔ Tire Displays, Tire Racks, Folding Racks



WALL MOUNT TIRE RACK

▪ **Designed and tested to meet your toughest standards** ▪ 500 lb./227 kg of tire and wheel assemblies kept off the floor to let you do the jobs that matter ▪ Long heavy-duty steel tubes of 83"/2108 mm to hold 8 SUV tire and wheel assemblies (8 x 245 tread) ▪ **DIMENSIONS:** 81-9/16" X 23-7/8" X 25-7/8" ▪ **MAX TIRE SIZE:** 865 mm / 34" OD) ▪ **TIRE CAPACITY:** 8 to 9 ▪ **LOAD CAPACITY:** 500 lb./224 kg ▪ **WEIGHT:** 42 lb.



751-00080

ASCOT NO.	MFG. NO.	CAPACITY	DIMENSIONS
751-00080	MWM-80	8-9 Tires	81-9/16" x 23-7/8" x 25-7/8"

DELUXE TIRE DISPLAY ON CASTERS

▪ **Provides an excellent compromise between strength and lightness** ▪ Equipped with casters that let you move it quickly and easily ▪ Allows you to store 16 tires with an outside diameter of up to 32"



751-00072

ASCOT NO.	MFG. NO.	CAPACITY	DIMENSIONS
751-00072	MTD-72	14-16 Tires	77" x 26-1/2" x 89"



STANDARD TIRE DISPLAY ON CASTERS

▪ **The standard tire display is 60" long and holds up to 14 tires, 7 on each of 2 tiers** ▪ This model is used a great deal by Goodyear and Michelin ▪ With 2 wheels and 2 steel feet, moving this rack requires the display truck. The truck acts as a lever, facilitating handling in snow, on gravel surfaces and on inclines



751-00060

ASCOT NO.	MFG. NO.	CAPACITY	DIMENSIONS
751-00060	MTD-60	10-14 Tires	64-1/2" x 26-1/2" x 76-1/2"

TRUCK TIRE FOLDING RACK

▪ **For greater ease of use in storing and handling your tires for heavy trucks or farm machines, this folding rack offers vertical tire storage for easy access** ▪ Each rack holds 8 tires and can be stacked 4 high, or 20 high when folded ▪ Fits easily in a trailer for shipping



751-08010

ASCOT NO.	MFG. NO.	CAPACITY	DIMENSIONS
751-08010	MTFR	8 Tires	93-1/2" x 40" x 55-1/2"

AUTO & FLEET SERVICE // TIRE DISPLAYS, RACKS & CARTS



⚠ **WARNING:** For more information go to www.P65Warnings.ca.gov.

➔ Wheel Displays, Tire Displays, Tire Carts, Dolly

Tire Displays, Racks & Carts (cont.)



DELUXE DISPLAY FOR PCR TIRES

- Ideal for showing your tires to your customers
- Can hold up to six tires with a diameter of up to 29" ▪ Complete with a pamphlet holder and 13 sliding strips of major tire brands



751-00016

ASCOT NO.	MFG. NO.	CAPACITY	DIMENSIONS
751-00016	MSTD-6	6 Tires	35" x 33" x 77-1/2" High



PCR / SUV TIRE DISPLAY

- New design features modern contours and a high-quality finish powder coated paint
- Solid steel structure and acrylic panels for long lasting life
- Equipped with steel header with acrylic panel to insert 4 specification sheets of displayed tires
- Personalize by adding logo to side panels
- **DIMENSIONS:** 63-3/16" x 23-7/8" x 47-1/2"
- **TIRE CAPACITY:** 4
- **MAX TIRE DIAMETER:** 31" / 787 mm OD
- **LOAD CAPACITY:** 550 lb./250 kg
- **WEIGHT:** 73 lb./33 kg



751-00774

ASCOT NO.	MFG. NO.	CAPACITY	DIMENSIONS
751-00774	MFSUVD	4 Tires	63-3/16" x 23-7/8" x 47-1/2"



WHEEL DISPLAY

- Will hold up to 8 wheel rims
- Rims can be as large as 25" in diameter and 12" wide
- Gives your customers rims visual exposure
- Made with 1 1/2" (28mm) round tube with brushed stainless steel finish
- Fully adjustable in height



751-00093

ASCOT NO.	MFG. NO.	CAPACITY	DIMENSIONS
751-00093	MWD	4-8 Wheels	28" x 28" x 81-5/8"



DOLLY FOR TIRE DISPLAYS

- Required to handle tire display units
- Only one is necessary even if you have several display units
- Compatible with all other makes of display units

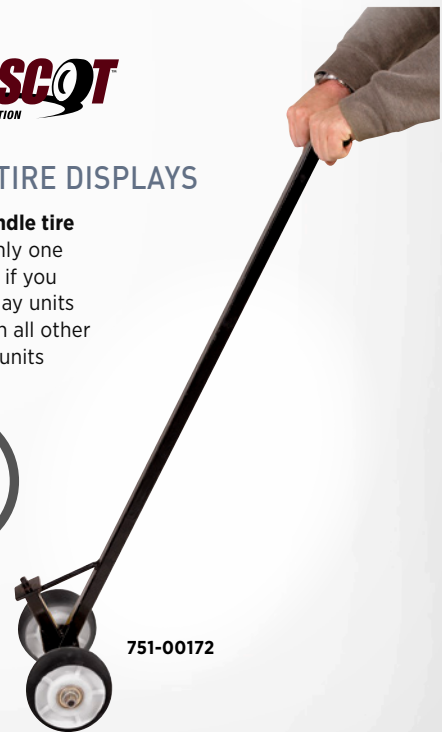

751-00172

ASCOT NO.	MFG. NO.	DESCRIPTION
751-00172	MD	Dolly for Tire Displays





➔ Tire Dolly, Tire Cart, Tire Cart Replacement Tires

TIRE DOLLY W/ CASTERS

- **300 lb. capacity** ▪ Ideal for moving tires around or for tire storage ▪ Includes (4) swivel, non-marking and smooth 3" casters, (1) equipped with brake
- Unique built-in compartment stackable design for space saving storage ▪ **SIZE:** 25.2" x 25.2" x 4.33"

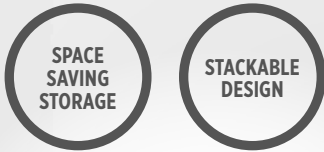

703-00509

TIRE RIDER TUFF TIRE CART

- **Easy to maneuver, even with a full load of tires** ▪ Can handle tires up to 35" in diameter ▪ Features a gas spring that automatically closes the arms and grips the tires ▪ All you have to do is to push down on the pedal, slide the cart under the stack of tires and release the pedal. The frame lines up the tire on its own ▪ Allows you to move tires 12 to 35 inches in size

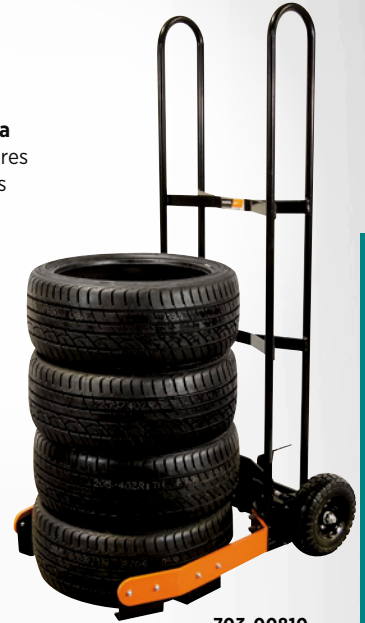

703-00810



ASCOT NO.	MFG. NO.	CAPACITY	DIMENSIONS
703-00810	MTC-E	6 to 8 tires	35" O.D. Max

TIRE CART REPLACEMENT TIRES/WHEELS

- **Flat-free foam design** ▪ **SIZE:** 10" x 3-1/2" ▪ Industrial inner & outer wheel bearings ▪ Sold as a pair of two
- Compatible with Martins tire carts



The Tire Dolly is ideal for moving tires around or for simply storing them.



703-00818

ASCOT NO.	MFG. NO.	DESCRIPTION
703-00509	TC0509	Tire Dolly w/ Casters

ASCOT NO.	MFG. NO.	DESCRIPTION
703-00818	PU1005ASC	Tire Cart Replacement Tires/Wheels



⚠ **WARNING:** For more information go to www.P65Warnings.ca.gov.

➔ Tire Carts

Tire Displays, Racks & Carts (cont.)



MTP, Inc.

EZ-1F ADJUSTABLE TIRE CART

- **Over 12,000 sold** ▪ No Lost Loads ▪ 22" closed - 36" Open
- Ships UPS or Fedex Ground - Saving Freight Cost ▪ 10" Semi-pneumatic Wheels - Full pneumatic available ▪ Patented Design ▪ Only 5 moving parts

ONLY 5 MOVING PARTS



703-00815

ASCOT NO.	MFG. NO.	DESCRIPTION
703-00815	EZ-1F	EZ-1F Adjustable Tire Cart

MARTINS
INDUSTRIES

TIRE RIDER CLASSIC TIRE CART

- **Made of galvanized steel and high quality wood** ▪ Cast iron/rubber wheels
- Foot operated mechanism ▪ Adjustable clamps ▪ Able to carry passenger and light truck tires of up to 35" in diameter and move 6 to 8 tires at a time

CAST IRON/RUBBER WHEELS

HEAVY DUTY

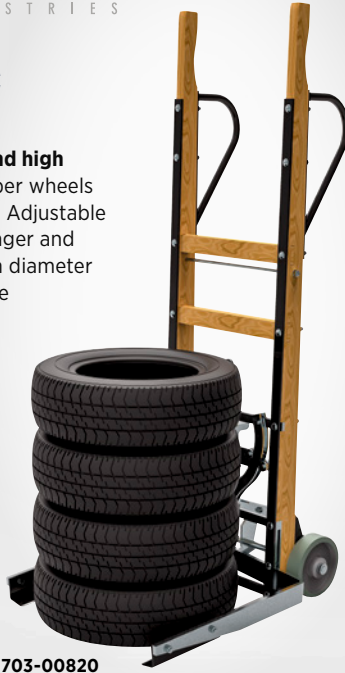

703-00820

ASCOT NO.	MFG. NO.	DESCRIPTION
703-00820	MWTC	Wooden Tire Cart

SMART TIRE CART

- **Works on passenger 15" tires up to truck size 245/70R19.5 tires**
- Moves mounted tires and wheel sets
- Moves tires in stacks of 8 to 10 high
- Stacks tires closer together than other carts which creates more storage space
- No foot pedals
- Great for loading and unloading trucks and containers
- Patented tilting action relieves stress off the user
- New push/pull system pushes the tires out of the SMART Cart arms without stress
- Fewer moving parts
- Easy to assemble ▪ "Patent Pending"

PATENTED TILT ACTION RELIEVES STRESS

NEW PUSH/PULL SYSTEM



703-47147



The Smart Tire Cart in use.

ASCOT NO.	MFG. NO.	CAPACITY	DIMENSIONS
703-47147	G471147HD	8 to 10 tires	Handles sizes from 15" to truck size 245/70R19.5



➔ Key Tags, Parts Return Bag, Floor Mats, Work Ticket Holder, Tire Label

Interior Protection Products



The Slip-N-Grip® protection system provides total protection for the customer's car while being serviced:

- Covers hold fast to the upholstery: A patented process laminates two distinctly different plastics together - the top layer allows a person to easily slide into and out of the vehicle and the bottom, or gripping layer, keeps the seat cover in place
- Unique process eliminates static electric clinging and wrinkling.

A complete line of vehicle interior protection products are available along with a service center roll dispenser.

PARTS RETURN BAG

- **Heavy plastic bag for holding old removed parts you've replaced** ▪ Keeps customer's vehicle and hands clean

ASCOT NO.	MFG. NO.	DESCRIPTION	SIZE
399-60098	FB-P9943-56	Parts Return Bag	14" x 22"

PAPER KEY TAG

- **Cost-effective, convenient solution for key control** ▪ Metal ring

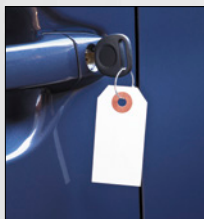

399-98313



ASCOT NO.	MFG. NO.	DESCRIPTION	SIZE	QUANTITY
399-98313	FB-P9833-13	Paper Key Tag with Metal Rings	1.5" x 2.75"	1,000/box

PLASTIC KEY TAG

- **Self-locking design holds keys secure** ▪ Large writing surface; holes are fully punched out eliminating "chads"
- Perfect for quickly tagging keys in a busy service area



399-99323

ASCOT NO.	MFG. NO.	DESCRIPTION	QUANTITY
399-99323	FB-P9933-23	White Plastic Key Tag - 4.5" x .75"	1000/package

WORK TICKET HOLDER

- **Heavy-duty sewn nylon fabric handle ensures durability even in harsh conditions** ▪ Durable brass grommet increases strength



399-99302

ASCOT NO.	MFG. NO.	DESCRIPTION	SIZE	QUANTITY
399-99302	FB-P9933-02	Work Ticket Holder	10.5" x 14.5"	25/box

PLASTIC FLOOR MAT

- **Slip-N-Grip® two-layer construction ensures plastic floor mat stays in place** ▪ Impervious to water, oil, grease and most shop chemicals



399-99432

ASCOT NO.	MFG. NO.	DESCRIPTION	QUANTITY
399-99432	FG-P9943-02	Plastic Floor Mat	500/roll

GENERIC ADHESIVE TIRE LABEL

- **Features sure-grip adhesive** ▪ Proper used tire labeling sells tires ▪ These labels will catch your customer's eye and promote sales

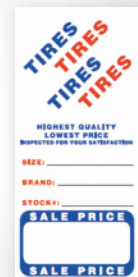

ASCOT NO.	MFG. NO.	DESCRIPTION	QUANTITY
399-99479	FB-P9943-79	Generic Adhesive Tire Label - 3" x 6"	500/roll

399-99479

➔ Tire Bag, Seat Cover, Steering Wheel Covers, Dispenser Racks



Tire Displays, Racks & Carts (cont.)

PLASTIC TIRE BAG

- 40% post-consumer recycled resin
- White film hides dirty tire
- Ideal for returning old tires or snow tires for storage



399-99429



The Plastic Tire Bag in use.

ASCOT NO.	MFG. NO.	DESCRIPTION	SIZE	QUANTITY
399-99391	FG-P9933-91	Extra Large Tire Bag	47" x 48" x 1.25 Mil	125/roll
399-99429	FG-P9943-29	Standard Tire Bag	36" x 40"	250/roll
399-99392	FG-P9933-92	Large Tire Bag	39" x 44"	250/roll

PLASTIC SEAT COVER

- Slip-N-Grip® seat covers have two distinct layers: the bottom layer grips the seat to stay in place and the top layer is smooth to allow easy entry and exit from the vehicle
- Protects bucket, bench and split seats



399-99415

ASCOT NO.	MFG. NO.	DESCRIPTION	QUANTITY
399-99415	FG-P9943-15	Plastic Seat Cover	500/roll

STEERING WHEEL COVER

- Keeps grease, dirt and other shop chemicals off of one of the most noticed and expensive parts on the car today
- Disposable steering wheel covers are made of clear polyethylene with stretch elastic grip feature
- Elastic design is easier to apply and remove than stretch wrap covers
- Unique double-band steering wheel covers stays in place while allowing access to airbags



Double Band steering wheel covers are made of clear polyethylene with stretch elastic grip feature. Elastic design is easier to apply and remove than stretch wrap covers. Unique double-band steering wheel covers stays in place while allowing access to airbags.

► **STANDARD SIZE:** Covers virtually all passenger cars and light trucks.

► **LARGE SIZE:** Fits the oversized steering wheels of heavy trucks and motor homes.

ASCOT NO.	MFG. NO.	DESCRIPTION	QUANTITY
399-99433	FB-P9943-33	Double Band Steering Wheel Cover (Standard Size)	500/box
399-99435	FB-P9943-35	Double Band Steering Wheel Cover (For Trucks)	250/box

FLOOR-RACK START-UP KIT

- Promotes your professional image by displaying your complete line of car interior protection products where your customers can see you putting them in their car
- Convenient roll dispenser work station provides organized storage, helps save employee time and shows your customers you care about their car



399-60000

ASCOT NO.	MFG. NO.	DESCRIPTION
399-60000	FK-P9943-76	Product Dispenser System (Includes Product)

FLOOR DISPENSER RACK

- Industry-leading dispenser system keeps products organized and within reach
- Presents "We Care" image and promotes cleanliness
- Retention straps prevent free-rolling and locking casters keep dispenser in place
- Top tray holds paper floor mats and other service items while lower tray provides extra storage



399-98893

ASCOT NO.	MFG. NO.	DESCRIPTION
399-98893	FB-P9833-89	Floor Dispenser Rack



➔ Paper Floor Mats, Key Tags, Tire Labels

PERSONALIZED PAPER FLOOR MATS

- **Either insert your logo where the footprints are or totally design a new layout**
- The stock is a high bulk 60 pound white sheet, size 17" x 22", with a one color imprint
- Minimum order of 3,000
- Camera ready art must be supplied for all logos - one time artwork charge



ASCOT NO.	DESCRIPTION
399-00005	Personalized Paper Floor Mats

399-00005

PRIME HEAVY DUTY PAPER FLOOR MATS

- **Treated/coated mats, made from premium prime/virgin paper**
- Keeps dirt, grease, oil, spills, leaks and other shop fluids out of your customer's vehicle during service
- Prime paper is suitable for all weather climates and heavy foot traffic
- Prime paper directly from paper mill provides same consistent quality every time
- Printed with UV ink
- Bright white paper produces vibrant, full color prints
- Recyclable
- **SIZE:** 17" x 19"
- **QUANTITY:** 500 per box



399-74980



Prime Heavy Duty Paper Floor Mat in use.

ASCOT NO.	MFG. NO.	DESCRIPTION
399-74980	M3273PP2280A	Prime Heavy Duty Paper Floor Mats - 17" x 19"

PLASTIC ARROW KEY TAG

- **Unique one piece key tag that attaches easily to the key ring with a hole for hanging on a board**
- Packaged 40 perforated sheets with 25 tags each
- 1000 per pack

ASCOT NO.	DESCRIPTION
399-00011	Plastic Arrow Key Tag

TIRE LABELS

- **2-1/2" x 6" label for easy identification of new, used and retreaded tires**
- Packed 500 per roll



601-00101

ASCOT NO.	MFG. NO.	DESCRIPTION
601-00101	TL-101	Tire Labels New-Used-Retread

Please contact us for further details regarding **INTERIOR PROTECTION PRODUCTS.**

AUTO & FLEET SERVICE // INTERIOR PROTECTION PRODUCTS

➔ Stud Guns, Studding Equipment, Stud Gun Repair & Conversion Kits

Stud Guns & Studding Equipment

STUD GUN, STUDDING EQUIPMENT



ASCOT NO.	MFG. NO.	DESCRIPTION
458-00010	10-G	Stud Gun. Standard of the Industry. Automatic, Light weight
458-00002	KFP2	Stud Feeder. Fully automatic with 110 Volt motor, fast loading. Provides positive stud orientation. Feeds up to 225 studs per minute
458-04048	4048	Feederboy Stud Gun. Designed for fast feeding studs of the AS-9 Gun Attaches with screw clamp. Operates by manually turning the feeder cap
458-00005	K-5	Stud Feeder. INCLUDES: shield for gun. Welded steel construction with saddle
458-00500	K-500	Studding Equipment Kit. INCLUDES: K-5 stand, AS-9 gun, KFP2 automatic stud feeder

UGIGRIP®, SELF-ADJUSTING CARBIDE TIRE STUD

- Delivers full-time traction, increases the safety, convenience and security
- To order studs to best fit your customers' tire, use the TSMI number recommended by the tire manufacturer



SINGLE FLANGE STUDS:

TSMI Size	11	12	13	15	169	17	19
Overall Length	.345"	.375"	.470"	.520"	.585"	.515"	.635"
Jacket Dia.	.197"	.197"	.197"	.197"	.197"	.197"	.250"
Bottom Dia.	.354"	354"	354"	354"	354"	354"	354"
Nearest 32" to Hole Depth	11/32"	12/32"	13/32"	15/32"	16/32"	17/32"	19/32"

STUDDING EQUIPMENT

- Lightweight, reduces road wear ▪ Steel 12SL, 13SL & 16SL meet requirements for Washington, Oregon & Idaho

ASCOT NO.	STUDDING GUN	USE WITH STUDS NUMBERED
458-00010	10G	TSMI-11-12-13-15-16-17
458-00011	10T	TSMI-19-21

PARTS BREAKDOWN

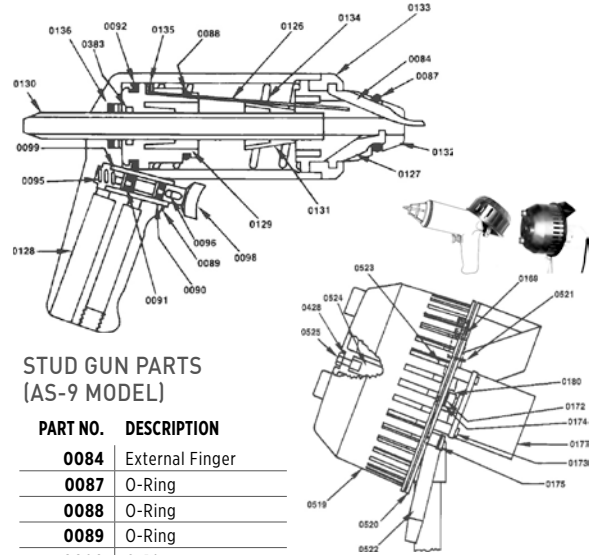

STUD GUN PARTS (AS-9 MODEL)

PART NO.	DESCRIPTION
0084	External Finger
0087	O-Ring
0088	O-Ring
0089	O-Ring
0090	O-Ring
0091	O-Ring
0092	Piston Cup
0095	Trigger Spring
0096	Trigger Pin
0098	Trigger
0099	Trigger Sleeve
0126	Pressing Spring
0127	Internal Finger
0128	Handle Body
0129	Piston
0130	Feed Tube
0131	Tapered Sleeve
0132	Head (Steel)
0133	Ring Nut
0134	Compression Spring
0135	Ring
0136	O-Ring
0383	Piston Cup

STUD FEEDER PARTS (KFP2 MODEL)

PART NO.	DESCRIPTION
0169	Deflector Spring
0172	Snap Ring
0173	Screw
0174	Washer
0175	Clamp
0180	Drive Shaft Pin
0428	Washer
0519	Feed Wheel
0520	Base Plate
0521	Retaining Ring
0522	Feed Tube
0523	Screw
0524	Shaft
0525	Hex Bolt

STUD GUN REPAIR & CONVERSION KITS

ASCOT NO.	STUDDING GUN	USE WITH STUDS NUMBERED
458-03810	0381	Tire Stud Mini Repair Kit. INCLUDES: (3) 0084 External Fingers; (1) 0087 O-ring; (1) 0088 O-ring; (3) 0126 Pressing Springs
458-03820	0382	Tire Stud Gun Large Repair Kit. INCLUDES: (6) 0126 Pressing Spring; (3) 0084 External Fingers; (2) 0087 O-ring; (2) 0088 O-ring; (1) 0092 Piston Cup; (1) 0136 O-ring
458-00911	00911	Conversion Kit. Converts AS-9 Gun to AS-11 Truck Model. INCLUDES: (1) 0401 Truck Feed Tube; (1) 0400 Truck Stud Gun Head; (3) 0127 Truck Stud Gun Internal Finger

AUTO & FLEET SERVICE // STUD GUNS & STUDDING EQUIPMENT



Fluid Pumps

BALCRANK PANTHER® HP PUMPS (3:1 AND 5:1)

Panther® series pumps are manufactured with a mechanical air-valve and piston design which is more forgiving to environments with contaminated air supply.

- This pump is perfect for quick lube, tire stores and small automotive maintenance facilities
- Suction tube sold separately • Bung adapter and pressure relief included



ASCOT NO.	MFG. NO.	DESCRIPTION
324-11320	1130-020	Stub Pump 3:1 w/ Bung Adapter
324-11321	1130-021	Stub Pump 5:1 w/ Bung Adapter



324-11320

BALCRANK EVOLUTION SERIES OIL AND GREASE HOSE REELS

- A solid performer; lightweight yet extremely rugged with sealed dual ball-bearing and full bore shaft
- Steel base and outlet arm
- All reels include hose, hose stop and a 2.5' connecting hosestop and a 2.5' connecting hose



ASCOT NO.	MFG. NO.	DESCRIPTION	
325-21413	2140-013	30' x 1/2" MP Oil Hose Reel	325-21413
325-21414	2140-014	50' x 1/2" MP Oil Hose Reel	
325-21419	2140-019	30' x 3/8" HP Grease Hose Reel	
325-21420	2140-020	50' x 3/8" HP Grease Hose Reel	

BALCRANK LYNX PUMPS

LYNX® series pumps are perfect for small shops that require an economical unit for a roll-around synthetic, or gear oil portable dispensers. These pumps are also good for over-head systems.

- LYNX® 3:1 is suitable for 1 dispense point up to 125', LYNX® 5:1 HD suitable 1-3 dispense points up to 500'
- Suction tube sold separately



ASCOT NO.	MFG. NO.	DESCRIPTION
324-11111	1110-007	Stub Pump, 3:1, w/ Bung Adapter
324-11112	1110-012	Stub Pump, 5:1, w/ Pressure Relief Kit and Bung Adapter
324-11135	1111-035	Tapper Stub Pump, 2:1, w/ Bung Adapter



324-11112

BALCRANK CLASSIC SERIES OIL AND GREASE HOSE REELS

The standard for over a decade.

- This all steel reel is for general duty, automotive dealerships and service garages
- Proven performance and reliable operation
- All reels include hose, hose stop and a 2.5' connecting hose



325-21211

ASCOT NO.	MFG. NO.	DESCRIPTION
325-21211	2120-011	30' x 1/2" MP Oil Hose Reel
325-21213	2120-013	50' x 1/2" MP Oil Hose Reel
325-21203	2120-003	30' x 3/8" HP Grease Hose Reel
325-21207	2120-007	50' x 3/8" HP Grease Hose Reel

Fluid Pumps (cont.)

DOUBLE DIAPHRAGM PUMPS

Balcrank Center Flo pumps handle a wide range of automotive fluids used for vehicle service.

- **Typical applications are transferring, dispensing, and evacuation up to 28 GPM CF30/ 53 GPM CF50**
- They can be used as stand-alone pumps for transfer applications or as system pumps in closed distribution systems for light weight fluids through hose reels
- *Pressure relief valve kit not included with pump and required for closed systems*

USED AS
STAND-ALONE
OR SYSTEM
PUMPS

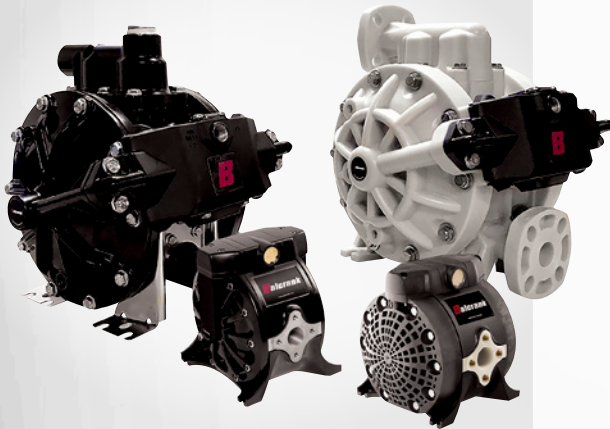

ASCOT NO.	MFG. NO.	DESCRIPTION
325-11226	1120-026A	CF30-Polypropylene, Teflon, Viton, Stainless Steel, Hytrel
325-11224	1120-024	CF30-Aluminum, Acetyl, Teflon, Buna-N, Stainless Steel
325-11238	1120-038	CF50-Polypropylene, Teflon, FKM, Stainless Steel, Hytrel
325-11237	1120-037	CF50-Aluminum, Hytrel, Acetyl, Buna-N, Stainless Steel
325-31202	3120-201	Pressure Relief Kit

METERED DISPENSE HANDLES

MECHANICAL REGISTRY METER (MR)

- **Aluminum body with one piece molded pointer knob resistant to impacts**
- Knob can be turned left or right without damage, no calibration required
- 33% improved flow over similar style competitive units
- 5-digit totalizer
- Keeps lifetime record of volume dispensed
- Flanged coupling prevents leaks commonly found on competitive threaded units and a built-in strainer to prevent debris from getting into handle and causing failure



323-33192

ASCOT NO.	MFG. NO.	DESCRIPTION
322-33189	3330-189	MR Metered w/ Rigid Extension, 1/4-Turn Nozzle
322-33192	3330-192	MR Metered w/ Flex-Memory Extension, 1/4-Turn Nozzle

DIGITAL REGISTRY METER (MR)

- **Comes with a precision machined aluminum die-cast fluid chamber for repeatable accuracy**
- Sealed battery compartment, meter uses 2-standard 'AAA' batteries
- Auto-sleep mode
- Trip mode to reconcile fluid inventory
- Non-resettable totalizer-maintains total volume dispensed by meter
- Flange coupled design prevents leakage around meter body and grip
- Economic designed grip for less hand fatigue
- Swivel protective cover
- 1/4-turn manual nozzle
- **ELECTRONIC METER ACCURACY: +/- 0.5%**

Measures in
pints, liters,
quarts or
gallons



322-33157

ASCOT NO.	MFG. NO.	DESCRIPTION
322-33157	3330-157	DR Metered w /Rigid Extension, 1/4-Turn Nozzle
322-33159	3330-159	DR Metered w/ Flex-Memory Extension, 1/4-Turn Nozzle



➔ Fluid Evacuation Packages, Self-Evacuating Drains

Drains & Pumps

BALCRANK FLUID EVACUATION PACKAGES

Balcrank Fluid Evacuation station for used motor oil and engine coolant. The used fluid evacuation packages come complete with everything you need with the exception of the used oil drain. Drains are ordered separately. Choose a drain based on the type of evacuation and product requirement. Balcrank uses 1" coupler for motor oil and a 3/4" coupler for antifreeze to prevent accidental cross fluid contamination.

- **ALL PACKAGES ABOVE INCLUDE:** AODD pump, hoses for air and fluid, cam-lock coupler, air filter/regulator and wall mounting bracket
- *Evacuation drain sold separately*

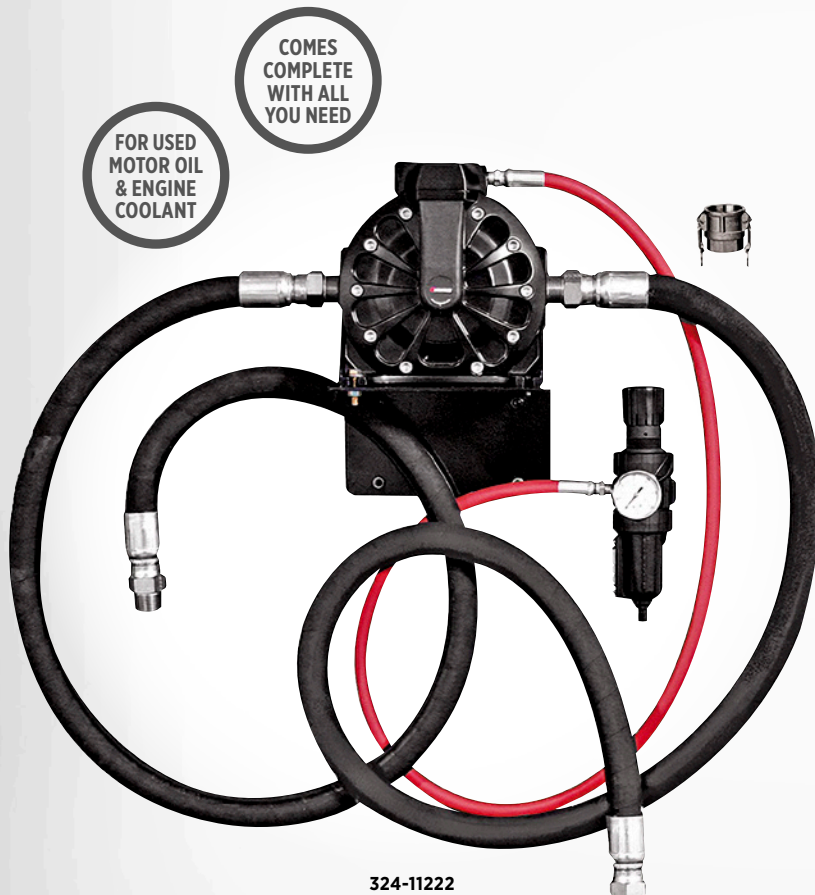

324-11222

ASCOT NO.	MFG. NO.	DESCRIPTION
324-11222	1121-022	CF30 Evacuation Package for Used Motor Oil
324-11223	1121-023	CF30 Evacuation package for Used Antifreeze
324-11224	1121-024	CF50 Evacuation package for Used Motor Oil
324-11225	1121-025	CF50 Evacuation package for Used Antifreeze

BALCRANK PUMPLESS SELF-EVACUATING DRAINS - ROUGHNECK II

Self-evacuating pumpless drain; no pump required!

- Drain used motor oil or antifreeze into a 23-gallon steel reservoir, then connect to an air supply to evacuate used motor oil or antifreeze into any approved used bulk fluid storage container
- **DURABLE POWDER COAT FINISH:** Black for motor oil and green for antifreeze



322-41122

322-41123

ASCOT NO.	MFG. NO.	CAPACITY	DESCRIPTION
322-41122	4110-022	23-Gallon	Roughneck II Drain for Used Motor Oil
322-41123	4110-023	23-Gallon	Roughneck II Drain for Used Antifreeze

AUTO & FLEET SERVICE // FLUID PUMPS



⚠ **WARNING:** For more information go to www.P65Warnings.ca.gov.

ASCOT SUPPLY CORPORATION

BUYER'S GUIDE

Drains & Pumps (cont.)

BALCRANK USED FLUID EVACUATION DRAINS

Premium series drains capture used fluid and allow for easy transfer to any bulk storage container using a cam-lock kit and evacuation pump system.

- **DURABLE POWDER COAT FINISH:** Black for motor oil or green for antifreeze
- **MADE IN THE USA**

BALCRANK SPILLGUARD USED FLUID EVACUATION DRAINS

Spillguard series drains capture used fluid and allow for easy transfer to any bulk storage container using a cam-lock kit and evacuation pump system.

- **Standard 3" caster set mounted on wide-track dolly**
- **DURABLE POWDER COAT FINISH:** Black for motor oil or green for antifreeze
- **MADE IN THE USA**

BALCRANK ROLLING VACUUM EVACUATION DRAIN

Balcrank Used Fluid Evacuators are used for engine types that require top motor oil evacuation.

- **These units use vacuum to remove fluid from top port of engine or through the dip stick**
- *Optional clear Bowl attachment can be added or ordered to make measuring fluid removed faster and easier*

10' REAR RUBBER WHEELS

23 GALLON STEEL TANK CAPACITY



19.25" DIA. CATCH BASIN

EASY ONE-HAND BOWL ADJUSTMENT



For engine types that require top motor oil evacuation. These units vacuum fluid from top port of engine or through the dip stick.



ASCOT NO.	MFG. NO.	CAPACITY	DESCRIPTION
322-41124	4110-024	23-Gallon	Premium Duty Used Oil Drain
322-41125	4110-025	23-Gallon	Premium Duty Used Antifreeze Drain

ASCOT NO.	MFG. NO.	CAPACITY	DESCRIPTION
322-41126	4110-026	16-Gallon	Spillguard Used Motor Oil Drain
322-41127	4110-028	16-Gallon	Spillguard Used Antifreeze Drain

ASCOT NO.	MFG. NO.	CAPACITY	DESCRIPTION
324-41456	4140-056	5.2-Gallon	Truck Drain for Antifreeze
324-41457	4140-057	5.2-Gallon	Truck Drain for Antifreeze w/ Clear Dome



➔ Steel Hand Pumps, Poly Hand Pumps

STEEL HAND PUMPS

HAND-OPERATED LEVER ACTION PUMP

▪ Suitable for dispensing lubricants and 100% anti-freeze ▪ **PUMP INCLUDES:** 3/4" gooseneck spout, 3/4" telescoping suction tube, 1-1/2" and 2" combination bung-adapter



323-13001

ASCOT NO.	MFG. NO.	DESCRIPTION
323-13001	1300-001	Steel Hand Lever Pump

POLY HAND PUMPS

HAND-OPERATED LEVER PUMP

▪ Suitable for dispensing water based media, detergents, soaps, anti-freeze, windshield wash, and lubricants ▪ **PUMP INCLUDES:** Built-in 2" bung adaptor with a lock nut incorporated in the pump body for pump positioning, telescoping suction tube and a 3/4" outlet equipped with an air vent cap, when loosened, breaks the siphon action of pump

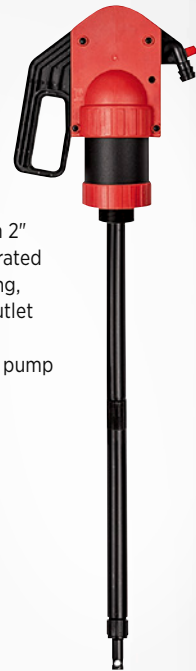

323-13019

ASCOT NO.	MFG. NO.	DESCRIPTION
323-13019	1300-019	Poly Hand Lever Pump

HAND-OPERATED ROTARY ACTION PUMP

▪ Suitable for dispensing lubricants and 100% anti-freeze ▪ **PUMP INCLUDES:** 1" gooseneck spout, 1" suction tube, and 2" bung adapter



323-13022

ASCOT NO.	MFG. NO.	DESCRIPTION
323-13022	1300-022	Steel Hand Rotary Pump

HAND-OPERATED ROTARY PUMP

▪ Suitable for dispensing water based media, detergents, soaps, anti-freeze, windshield wash, lubricants ▪ **PUMP INCLUDES:** 1" gooseneck spout, 1" telescoping suction tube, and 2" bung adapter



323-13133

ASCOT NO.	MFG. NO.	DESCRIPTION
323-13133	1300-0133	Poly Rotary Pump

AUTO & FLEET SERVICE // DRAINS & PUMPS

➔ Truck Drains, Truck & Trailer Wheel Pan

Drains & Pumps (cont.)



ROLLING FLOOR TRUCK DRAIN

- Comes pre-assembled allowing for immediate use
- Can be used for used motor oil or Antifreeze; decals provided for fluid identification
- **FEATURES:** Two fixed wheels and 1 swivel caster, double baffles with upper screen and side splash lip
- 3/4" or 1" Coupler kit sold separately



322-41203



ASCOT NO.	MFG. NO.	CAPACITY	DESCRIPTION
322-41203	4120-003	5.2-Gallon	Truck Drain for Antifreeze
322-41467	4140-067	—	Cam-Lock Coupler, Adapter and Valve Kit (3/4") for 4120-003 drain
322-41206	4120-006	26-Gallon	Truck Drain for Motor Oil
322-41461	4140-061	—	Cam-Lock Coupler, Adapter and Valve Kit (1") for 4120-003 drain



LOW PROFILE TRUCK OIL DRAIN WITH LID

- Holds 60 quarts
- Equipped with 4 rollers and a handle for transport and positioning under trucks
- Cover and curved side design help keep fluids from spilling during movement
- Convenient handles and pour spout facilitate fluid evacuation
- Rolls under most cab over axles so oil can be changed without jacks or jack stands
- **OVERALL HEIGHT:** 7-1/2", **WIDTH:** 32-1/4", **LENGTH:** 49"



322-19202

ASCOT NO.	MFG. NO.	DESCRIPTION
322-19202	19202	Low Profile Truck Oil Drain with Lid

TRUCK & TRAILER WHEEL PAN

- Prevents oil mess during wheel repair
- The pan fits rims with 13 3/4" ID and larger
- Handle compartments hold hand nuts out of the oil
- Made of polypropylene for durability
- Will not warp if oil is warm
- **CAPACITY:** 88 ounces



322-19852

ASCOT NO.	MFG. NO.	DESCRIPTION
329-19852	19852	Truck & Trailer Wheel Pan



➔ Transmission Drain Funnel, Dunk Tanks, Multi-Drain Tub, Drain Pans

TRANSMISSION DRAIN FUNNEL

- 22" by 23" heavy duty plastic lift drain funnel
- Extends the catch area of any lift drain
- Funnel catches any loose parts
- Prevents parts from falling through drain



322-17892

ASCOT NO.	MFG. NO.	DESCRIPTION
322-17892	17892	Transmission Drain Funnel

MULTI-DRAIN TUB

- 30-quart, all purpose, heavy duty, plastic drain tub
- For draining radiator, crankcase, transmission differential
- Accommodate autos and trucks
- Apron for washing and sorting parts



322-17922

ASCOT NO.	MFG. NO.	DESCRIPTION
322-17922	17922	Multi-Drain Tub

DUNK TANK

- Heavy duty plastic tire and tube test tank
- Features pyramid type ribs for extra support to prevent bowing
- Handles passenger tire sizes to wide oval and light duty truck tires



322-19822

HEAVY DUTY PLASTIC



322-02444

ASCOT NO.	MFG. NO.	DESCRIPTION
322-19822	2400-10	Passenger Car
322-02444	2400-44	SUV/Light Truck

4.5-GALLON OVAL DRAIN PAN

- New, smooth pan design is easy to wipe out and clean
- 6.25" pan height to fit tight spaces
- 1.125" outer diameter spout for quick and easy pouring of used fluids into most jugs
- Anti-splash lip helps prevent spills when carrying or pouring
- Multiple hand positions for carrying
- Made of high density polyethylene material that is resistant to chemicals and solvents



322-17972

NEW DESIGN



322-17982

ASCOT NO.	MFG. NO.	DESCRIPTION
322-17972	17972	Black Drain Pan (For Oil)
322-17982	17982	Green Drain Pan (For Coolant)

AUTO & FLEET SERVICE // DRAINS & PUMPS

➔ Cube Lube Tank, Oil Drains

Drains & Pumps (cont.)

SINGLE WALL UL-142 CUBE LUBE TANK

▪ **UL listed tanks - double wall** ▪ If tank is for used oil, a high level tank monitor is recommended



ASCOT NO.	MFG. NO.	DIMENSIONS (H X W X D)	THICKNESS	APPROX. WEIGHT
322-00125	DW125	38"x32"x26"	12 Gauge	170 lb.
322-00200	DW200	36"x60"x22"	12 Gauge	220 lb.
322-00201	DW200V	60"x36"x22"	12 Gauge	220 lb.
322-00250	DW250	34"x60"x28"	12 Gauge	290 lb.
322-00251	DW250V	60"x34"x28"	12 Gauge	290 lb.
322-00300	DW300	38"x60"x31"	12 Gauge	325 lb.
322-00301	DW300V	60"x38"x31"	12 Gauge	325 lb.
322-00350	DW350V	60"x41"x31"	12 Gauge	350 lb.
322-00500	DW500	60"x60"x33"	12 Gauge	450 lb.
322-00650	DW650	60"x78"x33"	10 Gauge	730 lb.
322-00750	DW750	60"x90"x33"	10 Gauge	820 lb.
322-01000	DW1000	60"x118"x33"	10 Gauge	1,025 lb.



8-GALLON OIL LIFT DRAIN

▪ **This specially shaped, translucent jug holds 8 gallons** ▪ Reinforced base will not warp with hot oil ▪ Has a wide working range from 36 1/2" to 74" ▪ Its lower center of gravity increases stability and four 2 1/2" ball bearing wheels swivel and roll easily ▪ Also has a heavy-duty adjustment clamp, large handle and big pour spout with threaded cap ▪ Large 15" funnel has strainer built-in to catch drain plugs ▪ Base of funnel is 1 3/4" wide



322-11102

ASCOT NO.	MFG. NO.	DESCRIPTION
322-11102	11102	8-Gallon Oil Lift Drain



18-GALLON OIL LIFT DRAIN

▪ **Translucent jug holds 18 gallons and will not warp with hot oil** ▪ Rolls easily with four heavy-duty 2 1/2" wheels ▪ Metal tubes extend working area from 36-1/2" to 77" ▪ Drains from the bottom with a brass drain valve ▪ Large 15" funnel has a built in strainer to catch drain plugs



322-17432

ASCOT NO.	MFG. NO.	DESCRIPTION
322-17432	17432	18-Gallon Oil Lift Drain



18-GALLON OIL LIFT DRAIN

▪ **18-gallon capacity** ▪ Four 3-1/2" ball bearing wheels ▪ 3/4" evacuation valve ▪ Spout for evacuation ▪ Hand grips on bottom and top ▪ Height adjusts from 48" to 71" ▪ Polyethylene body is translucent for easy viewing of oil level ▪ *Oil Drain Pump not included*

322-24026

ASCOT NO.	MFG. NO.	CAPACITY	HEIGHT (MAX.)	HEIGHT (MIN.)
322-24019	2400-19	18-Gallon	71"	48"
322-24026	2400-26	Oil Drain Pump		



8-GALLON OIL LIFT DRAIN

▪ **8-gallon capacity** ▪ Spout for evacuation ▪ Hand grips on bottom and top for ease in evacuation ▪ Four 3-1/2" ball bearing wheels ▪ Height adjusts from 48" to 71" ▪ Polyethylene body is translucent for easy viewing of oil level

322-24020

ASCOT NO.	MFG. NO.	CAPACITY	HEIGHT (MAX.)	HEIGHT (MIN.)
322-24020	2400-20	8-Gallon	71"	48"



➔ Oil Drains, Containment Vessel, Drum Funnel



30-GALLON OIL DRAIN W/ CASTERS

- **Four heavy duty 4" casters (2 fixed and 2 swivel)** ▪ Heavy duty polyethylene construction ▪ 3/4" evacuation valve
- Rugged 18" black polyethylene funnel with a 2" non-corrosive adjustable tube ▪ Height adjusts from 55" to 78" ▪ Oval shape ideal for easy movement in a garage or shop environment
- Orange heavy duty polyethylene body is translucent for easy viewing of oil level
- **DIMENSIONS:** 18"D x 24"W x 55"H

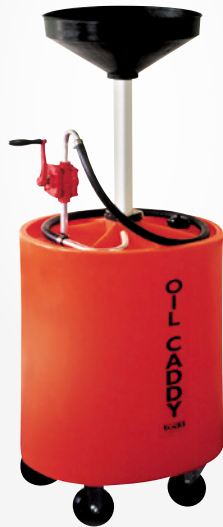

329-24068

ASCOT NO.	MFG. NO.	DESCRIPTION
329-24068	2400-68	30-Gallon Oil Drain w/ Casters



LOW BOY OIL DRAIN

- **Rolls under trucks or buses to drain oil or antifreeze with ease** ▪ Constructed of heavy duty polyethylene that will resist rust, dents, automotive fluids and other chemicals
- Gravity drain valve is recessed to protect it from damage and a wire screen in the pan prevents foreign matter from entering into the reservoir



322-24037

ASCOT NO.	MFG. NO.	CAPACITY	DESCRIPTION
322-24034	2400-34	17-Gallon	Low Boy Oil Drain
322-24037	2400-37	17-Gallon	Low Boy Oil Drain w/115V Evac

DOUBLE DRUM CONTAINMENT VESSEL

- **Perfect solution for storing your chemical drums** ▪ Drum pallets are designed so that hazardous spills can be safely contained in pallet basin, not on your floors or in the soil
- Pallets hold two 55 gallon drums ▪ Convenient forklift entry ▪ *Designed for in-plant use, not for transport*



ASCOT NO.	MFG. NO.	DESCRIPTION	322-24016
322-24016	SP1006A	Chemical Drum Storage Unit	



DRUM FUNNEL

- **Eliminates overspills while pouring** ▪ Large surface area permits drainage of multiple containers simultaneously
- **HIGHLY DURABLE:** Will resist rust, dents and other chemicals and will give many years of trouble-free service
- Fits all types of 55-gallon drums
- Patented design ▪ **COLOR:** yellow



322-24014

ASCOT NO.	MFG. NO.	DESCRIPTION
322-24014	2400-14	Drum Funnel



Please contact us for further details regarding **LUBRICATION EQUIPMENT.**

AUTO & FLEET SERVICE // DRAINS & PUMPS

➔ Oil Dispensers, Radiator Filler, Water/Anti-Freeze Bibb

Oil Accessories



6-QT. OIL DISPENSER

▪ **Translucent white (see-through) polyethylene material enables the user to read the liquid level on the container** ▪ Marked in both quarts and liters ▪ The flexible 8" pouring spout enables easy transfer of liquid ▪ The spout is white

ASCOT NO.	MFG. NO.	DESCRIPTION
329-19732	19732	6-Quart Oil Dispenser

329-19732

RADIATOR FILLERS

▪ **Long curved spout, balanced shape and handle positions** ▪ Weather resistant plastic ▪ 12-quart capacity



329-00505

ASCOT NO.	MFG. NO.	DESCRIPTION	CAPACITY
329-00505	6110-010	Black Plastic Radiator Filler	12 Quarts

8-QT. OIL DISPENSER WITH LID & CAP

▪ **8-Quart Dispenser with a spout cap and lid to keep out dirt, dust and other contaminants** ▪ Many large SUVs and trucks now require more oil — works great to transport bulk oil ▪ Translucent white polyethylene material enables the user to read the oil level on the container up to 8 quarts and is marked in both quarts and liters ▪ Flexible, removable 8" pouring spout enables easy transfer of liquid



329-19702

ASCOT NO.	MFG. NO.	DESCRIPTION
329-19702	19702	8-Quart Oil Dispenser with Lid & Cap

WATER/ANTI-FREEZE BIBB

▪ **Durable, full volume dispense nozzle for water, windshield wash and antifreeze** ▪ 1/4" NPT female inlet



329-18685

ASCOT NO.	MFG. NO.	DESCRIPTION
329-18685	3340-014	Water/Anti-Freeze Bibb

AUTO & FLEET SERVICE // OIL ACCESSORIES



➔ Oil Filter Pliers & Wrenches

SLIP JOINT HANDLE OIL FILTER PLIERS

▪ **Two-position, slip-joint handle produces the range of three separate conventional filter wrenches** ▪ Overall range 2 1/4" to 4" ▪ Jaws are bent at a 20-degree angle to fit more applications ▪ Sure grip teeth prevent slipping ▪ Cushioned handles provide comfort ▪ **OVERALL LENGTH: 11-1/2"**



329-50750

ASCOT NO.	MFG. NO.	DESCRIPTION
329-50750	50750	Slip Joint Handle Oil Filter Pliers

SWIVEL GRIP OIL FILTER WRENCHES

▪ **Handle swivels to clear obstructions** ▪ Features the swivel handle, gripper "teeth" and 1" wide stainless steel band ▪ The swivel handle makes it easy to turn filters in hard to reach locations ▪ Vinyl covered handle



329-53500

ASCOT NO.	MFG. NO.	DESCRIPTION
329-53500	53500	Standard Swivel Grip Oil Filter Wrench: 3.5" - 3.875" Range
329-53700	53700	Small Swivel Grip Oil Filter Wrench: 2.875" - 3.25" Range

HEAVY DUTY END CAP OIL FILTER WRENCHES

End cap filter wrenches have been improved by adding welds to hold a steel disc to the top of the wrench.

▪ **Cup design allows easy filter removal and installation from the end of the filter, even in the tightest locations** ▪ End cap filter wrenches fit the most popular domestic and import vehicles ▪ 14 flutes ▪ Use with 3/8 in. square drive ▪ These low-profile sockets are specially designed for operating clearance ▪ Welded steel disc on top for extra strength ▪ Heat treated steel ▪ 3/8" drive



329-61570



ASCOT NO.	MFG. NO.	DESCRIPTION
329-61570	61570	Heavy Duty End Cap Oil Filter Wrench: 76 mm - 14 Flutes
329-61600	61600	Heavy Duty End Cap Oil Filter Wrench: 65 mm - 14 Flutes

IMPORT CAR OIL FILTER WRENCH

▪ **Fits filters from 2 1/2" to 3 1/8"** ▪ Removes all oil filters from 2 1/2" to 3 1/8" in diameter ▪ This extra large range enables the 63600 wrench to fit most all import car filters plus the common 3" domestic car filters ▪ Steel jaws grip filter without slipping ▪ Works in tight spots from the front of the filter using 3/8" drive



329-63600

ASCOT NO.	MFG. NO.	DESCRIPTION
329-63600	63600	Import Car Oil Filter Wrench

➔ Face Protection, Hearing Protection, Safety & Traffic Control Products

Safety Products

EYE AND FACE PROTECTION



396-51400



396-51450



396-53300



396-53400

ASCOT NO.	MFG. NO.	DESCRIPTION
396-51400	5140	Standard Face Shield (Clear) - Impact-resistant polycarbonate shield, for general grinding applications
396-51450	5145	Deluxe Face Shield (Clear) - Impact-resistant polycarbonate shield, aspherical lens for larger range of protection
396-53300	5330	NSX Turbo Safety Glasses (Clear) - High-impact polycarbonate lens, UV protection, scratch resistant, non-slip temples
396-53400	5340	NSX Safety Glasses (Clear) - High-impact polycarbonate lens, UV protection, anti-fog and scratch resistant

HEARING PROTECTION



396-61000



396-61090



396-61050



396-61110

ASCOT NO.	MFG. NO.	DESCRIPTION
396-61000	6100	Foam Ear Plugs, Uncorded (Blue) - Super-soft pre-shaped foam ear plugs (Dispenser box QTY: 200 pair)
396-61090	6109	Silicone Ear Plugs, Uncorded (Orange) - Triple flange design creates a secure fit (Dispenser box QTY: 200 pair)
396-61050	6105	Standard Ear Muffs - Lightweight muff-style hearing protector, under-the-chin, over-the-head or behind-head wear
396-61110	6111	Professional Ear Muffs - Superior protection, universal adjustment, comfortable and foldable, push ear cups

CLASS 2 SAFETY VEST

■ 100% polyester mesh, 2" wide reflective tape, hook-and-loop closure, ANSI/ISEA 107-2015 Class 2 Type R ■ Available in Orange (M-4XL) and Yellow* (M-3XL)



ASCOT NO.	MFG. NO.	DESCRIPTION
396-21208	692-1208	Safety Vest, Orange (Medium)
396-21209	692-1209	Safety Vest, Orange (Large)
396-21210	692-1210	Safety Vest, Orange (X-Large)
396-21211	692-1211	Safety Vest, Orange (2X-Large)
396-21212	692-1212	Safety Vest, Orange (3X-Large)
396-21213	692-1213	Safety Vest, Orange (4X-Large)
396-01208	690-1208	Safety Vest, Yellow (Medium)
396-01209	690-1209	Safety Vest, Yellow (Large)
396-01210	690-1210	Safety Vest, Yellow (X-Large)
396-01211	690-1211	Safety Vest, Yellow (2X-Large)
396-01212	690-1212	Safety Vest, Yellow (3X-Large)

* There is no Yellow 4XL.

AUTO & FLEET SERVICE // SAFETY PRODUCTS

➔ First Aid, Driveway Signal & Hose, DOT Conspicuity Tape

FIRST AID KITS



ASCOT NO.	MFG. NO.	DESCRIPTION
396-60010	6001	Single Person First Aid Kit - Lightweight and compact, contains essential supplies for light injuries
396-60250	6025	25 Person First Aid Kit - Multi-functional designed for up to 25 employees, contains essential supplies for medium to light injuries, wall mount hardware included

EYE WASH STATIONS



396-51320



396-51340

ASCOT NO.	MFG. NO.	DESCRIPTION
396-51320	5132	Personal Eye Wash Station - Dual-bottle station for temporary first aid (two 16oz. bottles), directions on station for fast reference, replacement bottles sold separately
396-51340	5134-00	9-Gallon Eye Wash Station - One-hand operation, no plumbing required, provides min. of 15 minutes flushing period, includes mounting bracket, inspection tag, tamper resistant tie, and preservative



DRIVEWAY SIGNAL AND HOSE

▪ Know when you have a customer at the pumps with this 6" diameter driveway signal bell ▪ Completely self-contained unit makes installation easy ▪ Each signal is manufactured to give you a signal that will perform under prolonged use



392-00805

ASCOT NO.	MFG. NO.	DESCRIPTION
392-00805	805	Driveway Signal - 110V 6" Dia. Bell
392-00838	838	50' Coil of Driveway Signal Hose
392-00839	839	300' Coil of Driveway Signal Hose



DOT CONSPICUITY TAPE

▪ Meets all Federal and State certifications ▪ Micro prismatic technology ▪ Thin and flexible ▪ 10-year durability



396-62150

ASCOT NO.	MFG. NO.	DESCRIPTION
396-62150	CT6R6W2150	2" x 150' (6" Red, 6" Silver)
396-72182	CT11R7W2X18	2" x 18" Strip (11" Red, 7" Silver)
396-72150	CT11R7W2150	2" x 150' (11" Red, 7" Silver)
396-82150	CTR2150	2" x 150' Solid Red
396-92150	CTW 2150	2" x 150' Solid Silver
396-93150	CTY2150	2" x 150' Solid Yellow

➔ Compact Fogger, Hand Sanitizer Gel, Disinfectant/Sanitizer

Safety Products (cont.)

DISINFECTANT/SANITIZER

▪ **EPA Registered Disinfectant/Sanitizer/Deodorizer/ Mildewstat** ▪ Effective against many common viruses including the common flu, HIV-1, HBV, HCV, Human Coronavirus and SARS associated Coronavirus ▪ Designed for use in places where disinfection, sanitization and deodorization is of prime importance ▪ Great for use on the interior of vehicles after maintenance has been performed ▪ Effective in the presence of 5% serum contamination ▪ Fast acting & odorless



395-60414



395-60415



395-60430

ASCOT NO.	MFG. NO.	DESCRIPTION
395-60414	60410-4	(4) 1-Gallon Bottles
395-60415	60410-5	5-Gallon Pail
395-60430	60410-30	30-Gallon Drum



LOW VOLUME COMPACT FOGGER

▪ **Portable hose-end fogger makes it easy to fog hard-to-reach areas or where fixed location foggers are impractical** ▪ Fill the bottle, connect compressed air and press the thumb gun activator ▪ Atomizes and sprays chemical solutions using only compressed air ▪ Venturi action draws pre-diluted chemical from the attached bottle ▪ Damp fog (mist) fills the air and covers exposed surfaces with chemical, including hard-to-reach areas ▪ Fog/mist can be adjusted: Included metering tips can reduce chemical usage for "drier" output; or an optional needle valve can reduce air flow for "wetter" output



395-95000

ASCOT NO.	MFG. NO.	DESCRIPTION
395-95000	M2020	Low Volume Compact Fogger
395-43793	443793	Colored Metering Tips

HAND SANITIZER GEL

▪ **75% Ethanol Gel** ▪ **EFFECTIVELY KILLS THE FOLLOWING TYPES OF MICROORGANISMS:** Candida albicans, Staphylococcus aureus, Pseudomonas aeruginosa and E.coli ▪ No artificial fragrance ▪ Use only in a well-ventilated area as fumes may be harmful ▪ Keep away from heat, spark, electrical, fire or flame ▪ Non-sterile solution



396-50674



395-50675



395-50676

ASCOT NO.	MFG. NO.	DESCRIPTION
396-50674	50674MB	Hand Sanitizer Gel 3.38 oz. (48 per Case)
396-50675	50675MB	Hand Sanitizer Gel 10.14 oz. (12 per Case)
396-50676	50676MB	Hand Sanitizer Gel 16.91 oz. (12 per Case)



➔ Rubber Wheel Chock, OTR Wheel Chock, Urethane Wheel Chocks

Wheel Chocks

RUBBER WHEEL CHOCK

- **Durable rubber construction** ▪ Features an eye bolt for chain or rope attachment
- Ribbed pyramid design
- Either side of wheel chock can be positioned against the tire
- Sold individually ▪ **WEIGHT:** 10 lb. (4.5kg)



396-15300

ASCOT NO.	MFG. NO.	DESCRIPTION
396-15300	15300	Rubber Wheel Chock

OTR WHEEL CHOCK

- **DIMENSIONS:** 12" x 10" x 12" ▪ Designed for heavy duty truck and mining equipment
- 20" rope attached for convenience
- **NET WEIGHT:** 27.5 lb.



396-00102

ASCOT NO.	MFG. NO.	DESCRIPTION
396-00102	TS102	OTR Wheel Chock

URETHANE WHEEL CHOCKS

- **SOLID LIGHTWEIGHT CONSTRUCTION** ▪ High impact urethane material
- Non-conductive, no threat to puncture the tire
- Durable, lightweight and easy to use
- Extensively field tested



396-15336



396-15337



396-15338



396-15339



396-15342



396-15353

ASCOT NO.	MFG. NO.	TIRE SIZE	DIMENSIONS (LXWXH)	WEIGHT
396-15336	15336	35" to 55" (90 cm to 140 cm)	13.3" x 8.6" x 7.8" (34 cm x 22 cm x 20 cm)	7.7 lb. (3.5 kg)
396-15337	15337	47" to 86" (120 cm to 220 cm)	18" x 12" x 9" (47.5 cm x 30.5 cm x 22.5 cm)	13 lb. (6 kg)
396-15338	15338	70" to 118" (180 cm to 300 cm)	22.5" x 13" x 14" (57 cm x 34 cm x 35.5 cm)	19.8 lb. (9 kg)
396-15339	15339	110" to 165" (280 cm to 420 cm)	26.7" x 13" x 14" (68 cm x 33.7 cm x 35.5 cm)	30.86 lb. (14 kg)
396-15342	15342	86" to 137.8" (220 cm to 350 cm)	24" x 13.5" x 12" (62.1 cm x 34.3 cm x 32.3 cm)	24.3 lb. (11 kg)
396-15353	15353	47" to 70" (120 cm to 180 cm)	13.38" x 9.84" x 7.8" (34 cm x 25 cm x 22.5 cm)	13.66 lb. (6.2 kg)



⚠ **WARNING:** For more information go to www.P65Warnings.ca.gov.



Rubber Blocks & Lift Pads

AUTO & FLEET SERVICE // RUBBER BLOCKS & LIFT PAD

RUBBER LIFT PAD (5" ROUND)

▪ **RUBBER PAD DIMENSIONS:** 5" round ▪ Kit of four rubber pads ▪ Replacement pads for Nussbaum lifts

ASCOT NO.	MFG. NO.	DESCRIPTION
309-00003	JOK03M	Rubber Lift Pad - 5" Round

309-00003



RUBBER LIFT PAD (3.25" X 4")

▪ **RUBBER PAD DIMENSIONS:** 3.25" x 4" ▪ Kit of four rubber pads ▪ Replacement pads for Rotary SPO10, SPO12 lifts

ASCOT NO.	MFG. NO.	DESCRIPTION
309-00022	JOK22D	Rubber Lift Pad - 3.25" x 4"

309-00022



RUBBER LIFT PAD (4" X 5")

▪ **RUBBER PAD DIMENSIONS:** 4" x 5" ▪ Kit of four rubber pads ▪ Replacement pads for Ammco, Ben Pearson lifts

ASCOT NO.	MFG. NO.	DESCRIPTION
309-00005	JOK05M	Rubber Lift Pad - 4" x 5"

309-00005



RUBBER LIFT PAD (5.25" ROUND)

▪ **RUBBER PAD DIMENSIONS:** 5.25" round ▪ Kit of four rubber pads ▪ Replacement pads for Challenger CL10, Quality lifts

ASCOT NO.	MFG. NO.	DESCRIPTION
309-00014	JOK140	Rubber Lift Pad - 5.25" Round

309-00014



RUBBER LIFT PAD (5" X 5")

▪ **RUBBER PAD DIMENSIONS:** 5" x 5" ▪ Kit of four rubber pads ▪ Replacement pads for Forward, Worth, American, Gemini, Grand, Tuxedo, Eagle, Whip lifts

ASCOT NO.	MFG. NO.	DESCRIPTION
309-00007	JOK07M	Rubber Lift Pad - 5" x 5"

309-00007



RUBBER BLOCK 1.5"

▪ **RUBBER BLOCK DIMENSIONS:** 6" x 4" ▪ Kit of four 1.5" rubber blocks ▪ Spacer blocks for Rotary Airjacks and all Mid-Rise pad lifts

ASCOT NO.	MFG. NO.	DESCRIPTION
309-00011	JORB-1	Rubber Block 1.5"

309-00011



RUBBER LIFT PAD (4" X 4")

▪ **RUBBER PAD DIMENSIONS:** 4" x 4" ▪ Kit of four rubber pads ▪ Replacement pads for Challenger CL9 and CL10 lifts

ASCOT NO.	MFG. NO.	DESCRIPTION
309-00009	JOK090	Rubber Lift Pad - 4" x 4"

309-00009



RUBBER BLOCK 3"

▪ **RUBBER BLOCK DIMENSIONS:** 6" x 4" ▪ Kit of four 3" rubber blocks ▪ Spacer blocks for Rotary Airjacks and all Mid-Rise pad lifts

ASCOT NO.	MFG. NO.	DESCRIPTION
309-00013	JORB-3	Rubber Lift Pad - 4" x 4"

309-00013



➔ Nitrile Gloves, Mechanics Gloves, High Visibility Mechanics Gloves

Mechanic's Gloves

NITRILE GLOVES

- For industrial and automotive applications
- Powder-free
- **THICKNESS:** 6 mil
- Thick material for extra comfort and elasticity
- **QUANTITY:** 100 per box, 10 boxes per case



ASCOT NO.	MFG. NO.	DESCRIPTION
396-00101	BLK-S	Black Nitrile Glove (Small)
396-01102	BLK-M	Black Nitrile Glove (Medium)
396-00103	BLK-L	Black Nitrile Glove (Large)
396-00104	BLK-XL	Black Nitrile Glove (XL)
396-00105	BLK-XXL	Black Nitrile Glove (XXL)



RPG NITRILE MICRO-DIAMOND GLOVES

- **Textured finish** ▪ For industrial and automotive applications
- Powder-free ▪ **THICKNESS:** 6 mil Not made from natural rubber latex
- **QUANTITY:** 100 per box, 10 boxes per case



396-00301

396-00401

ASCOT NO.	MFG. NO.	DESCRIPTION
396-00301	32806BK240R2	Micro Diamond Black Nitrile Glove (Small)
396-00302	32806BK240R3	Micro Diamond Black Nitrile Glove (Medium)
396-00303	32806BK240R4	Micro Diamond Black Nitrile Glove (Large)
396-00304	32806BK240R5	Micro Diamond Black Nitrile Glove (XL)
396-00305	32806BK240R6	Micro Diamond Black Nitrile Glove (XXL)
396-00401	32806OR240R2	Micro Diamond Orange Nitrile Glove (Small)
396-00402	32806OR240R3	Micro Diamond Orange Nitrile Glove (Medium)
396-00403	32806OR240R4	Micro Diamond Orange Nitrile Glove (Large)
396-00404	32806OR240R5	Micro Diamond Orange Nitrile Glove (XL)
396-00405	32806OR240R6	Micro Diamond Orange Nitrile Glove (XXL)



RPG MECHANIC'S GLOVES

- **Black synthetic leather palm with small patches**
- Features blue spandex on back, neoprene on knuckle, 4cm wide elastic, hook & loop



396-10011

ASCOT NO.	DESCRIPTION
396-10011	RPG Mechanic's Gloves

HIGH VISIBILITY MECHANICS GLOVES

- **Grey synthetic leather with silicon printing on palm** ▪ High visibility Spandex back with back of the hand protection ▪ Impact protection ▪ Hook and loop ▪ One size fits most



396-14202

396-14201

ASCOT NO.	MFG. NO.	DESCRIPTION
396-14201	FGM-420	Green/Black Mechanics Gloves - Pair
396-14202	FOM-420	Orange/Black Mechanics Gloves - Pair

AUTO & FLEET SERVICE // MECHANIC'S GLOVES

➔ Work Gloves, Colored Leather Gloves, High Visibility Leather Gloves

Mechanic's Gloves (cont.)



WORK GLOVES

Gaither's Work Gloves are designed to provide the best possible protection while still delivering the grip and flexibility required for performing intricate and complex tasks.

- Perfect for tire maintenance and general shop use
- Machine washable
- Impact protection
- Double Stitched
- Industrial grade hook and loop
- Slip-free silicone grip



ASCOT NO.	MFG. NO.	DESCRIPTION
396-49101	G49110S	Small Work Gloves
396-49102	G49110M	Medium Work Gloves
396-49103	G49110L	Large Work Gloves
396-49104	G49110XL	Xtra Large Work Gloves

COLORED LEATHER DOUBLE PALM WORK GLOVES

- Split leather double palm
- Colored fabric on the back of the hand
- Half fleece lining
- 12 pairs per package



396-55221

396-55222

ASCOT NO.	MFG. NO.	DESCRIPTION
396-55221	AB-R	Red Leather Double Palm Work Gloves
396-55222	AB-G	Green Leather Double Palm Work Gloves

MISCELLANEOUS HAND PROTECTIVE GLOVES



396-06780



396-40317



396-55220

ASCOT NO.	DESCRIPTION
396-06780	Wet Grip Neoprene Glove. Protects Against Acids, Caustics, Oils, Greases And Many Solvents. 5-Piece Flannel Liner
396-40317	Power Grip with Latex Premium Grip
396-55220	Leather Palm Glove with Safety Cuff, Elastic

HIGH VISIBILITY DUAL COLOR LEATHER DOUBLE PALM GLOVES

- Split leather double palm
- High visibility green and orange colors
- Half fleece lining
- 12 pairs per package



396-55223

ASCOT NO.	MFG. NO.	DESCRIPTION
396-55223	AB-HVDC	High Visibility Dual Color Leather Double Palm Gloves